

μAF771 SINGLE • μAF772 DUAL μAF774 QUAD BIFET OPERATIONAL AMPLIFIER FAMILY FAIRCHILD LINEAR INTEGRATED CIRCUITS

GENERAL DESCRIPTION — These monolithic JFET input operational amplifiers incorporate well matched ion implanted JFETs on the same chip with standard bipolar transistors. The key features of these op amps are low input bias currents in the sub nanoamp range plus high slew rate (13 V/μs typically) and wide bandwidth (3.0 MHz typically).

- **LOW INPUT BIAS CURRENT** — 200 pA FOR μAF77X
- **LOW INPUT OFFSET CURRENT** — 100 pA FOR μAF77X
- **HIGH SLEW RATE** — 13 V/μs TYPICALLY
- **WIDE BANDWIDTH** — 3.0 MHz TYPICALLY

ABSOLUTE MAXIMUM RATINGS

Supply Voltage	±18 V
Internal Power Dissipation (Note 1)	
DIP Package (9A) (6A)	670 mW
Molded Mini DIP Package (6T) (9T)	310 mW
Hermetic Package (5S)	500 mW
Differential Input Voltage	±30 V
Input Voltage Range (Note 2)	±16 V
Output Short Circuit Duration	continuous
Storage Temperature Range	
(5S) (6A)	-65°C to +150°C
(9A) (9T)	-55°C to +125°C
Operating Temperature Range	
Commercial (μAF77XA, μAF77XB, μAF77X, μAF77XL)	0°C to +70°C
Military (μAF77XAM, μAF77XBM)	-55°C to +125°C
Pin Temperature	
Molded Package (9T, 9A) Soldering 10 s	260°C
Hermetic Package (5S, 6A, 6T) Soldering 60 s	300°C

5

SCHEMATIC DIAGRAM (Typical Channel)

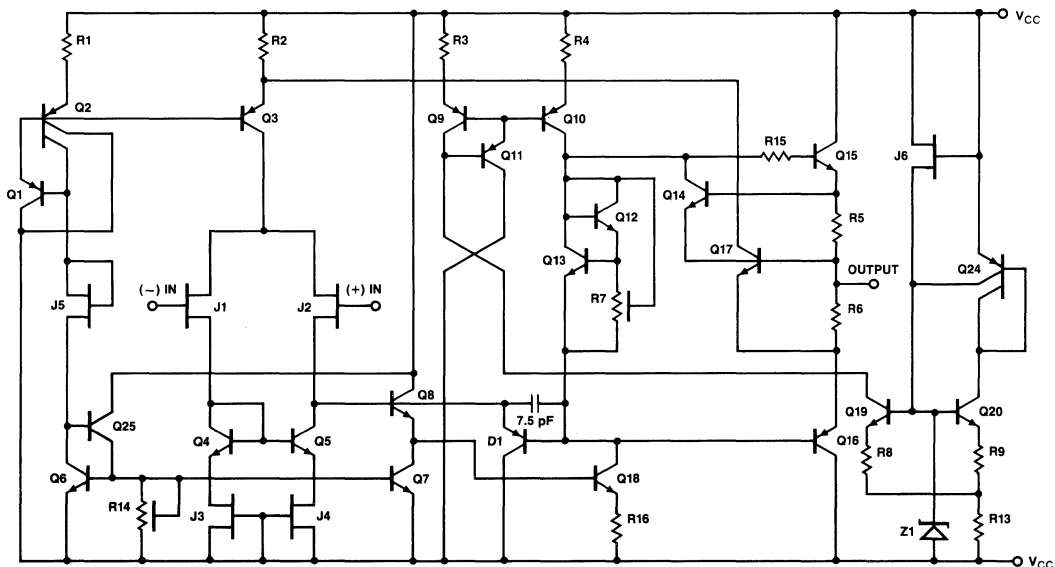

DC ELECTRICAL CHARACTERISTICS – COMMERCIAL GRADE DEVICES

SYMBOL	CHARACTERISTICS	CONDITIONS	μ AF77XA			μ AF77XB			μ AF77X			μ AF77XL			UNITS
			MIN	TYP	MAX	MIN	TYP	MAX	MIN	TYP	MAX	MIN	TYP	MAX	

The Following Specifications Apply for $V_S = \pm 15$ V, $T_A = 25^\circ\text{C}$

V_{OS}	Input Offset Voltage	Note 3 $R_S = 10$ k Ω	-	-	2.0	-	-	5.0	-	-	10.0	-	-	15.0	mV
I_{OS}	Input Offset Current	Notes 3, 4 $T_J = 25^\circ\text{C}$	-	-	50	-	-	50	-	-	100	-	-	100	μ A
I_B	Input Bias Current	Notes 3, 4 $T_J = 25^\circ\text{C}$	-	50	100	-	50	100	-	50	200	-	50	200	μ A
R_{IN}	Input Resistance		-	10^{12}	-	-	10^{12}	-	-	10^{12}	-	-	10^{12}	Ω	
A_{VOL}	Large Signal Voltage Gain	$V_O = \pm 10$ V $R_L = 2$ k Ω	50	100	-	50	100	-	50	100	-	50	100	-	V/mV
I_{SC}	Short Circuit Current		-	25	-	-	25	-	-	25	-	-	25	-	mA
I_S	Supply Current	Per Amplifier	-	-	2.8	-	-	2.8	-	-	2.8	-	-	2.8	mA

The Following Specifications Apply for $V_S = \pm 15$ V, $0^\circ\text{C} \leq T_A \leq 70^\circ\text{C}$

V_{OS}	Input Offset Voltage	Note 3 $R_S = 10$ k Ω	-	-	4.0	-	-	7.0	-	-	13	-	-	20	mV
$\Delta V_{OS}/\Delta T$	Average TC of Input Offset Voltage	$R_S = 10$ k Ω	-	10	-	-	10	-	-	10	-	-	10	-	$\mu\text{V}/^\circ\text{C}$
I_{OS}	Input Offset Current	Notes 3, 4	-	-	2.0	-	-	2.0	-	-	4.0	-	-	4.0	nA
I_B	Input Bias Current	Notes 3, 4	-	-	4.0	-	-	4.0	-	-	8.0	-	-	8.0	nA
A_{VOL}	Large Signal Voltage Gain	$V_O = \pm 10$ V $R_L = 2$ k Ω	25	-	-	25	-	-	25	-	-	25	-	-	V/mV
V_O	Output Voltage Swing	$R_L = 10$ k Ω $R_L = 2$ k Ω	± 12	-	-	± 12	-	-	± 12	-	-	± 12	-	-	V
V_{CM}	Input Common Mode Voltage Range		± 11	+15 -12	-	± 11	+15 -12	-	± 11	+15 -12	-	± 11	+15 -12	-	V
CMRR	Common Mode Rejection Ratio	$R_S = 10$ k Ω	80	-	-	80	-	-	70	-	-	70	-	-	dB
PSRR	Supply Voltage Rejection Ratio	$R_S = 10$ k Ω	80	-	-	80	-	-	70	-	-	70	-	-	dB
I_S	Supply Current	Per Amplifier	-	-	3.0	-	-	3.0	-	-	3.0	-	-	3.0	mA

INPUT OFFSET VOLTAGE NULL CIRCUITS

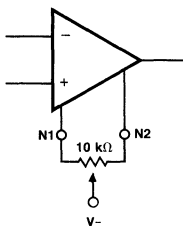

(μ AF771 and μ AF772 — 14 pin)

FAIRCHILD • μ AF771 SINGLE • μ AF772 DUAL • μ AF774 QUAD BIFET

DC ELECTRICAL CHARACTERISTICS – MILITARY GRADE DEVICES

SYMBOL	CHARACTERISTICS	CONDITIONS	μ AF77XAM			μ AF77XBM			UNITS
			MIN	TYP	MAX	MIN	TYP	MAX	
The Following Specifications Apply for $V_S = \pm 15$ V, $T_A = 25^\circ$C									
V_{OS}	Input Offset Voltage	$R_S = 10$ k Ω Note 3	–	–	2.0	–	–	5.0	mV
I_{OS}	Input Offset Current	Notes 3, 4 $T_J = 25^\circ$ C	–	–	50	–	–	50	μ A
I_B	Input Bias Current	Notes 3, 4 $T_J = 25^\circ$ C	–	50	100	–	50	100	μ A
R_{IN}	Input Resistance		–	10^{12}	–	–	10^{12}	–	Ω
A_{VOL}	Large Signal Voltage Gain	$V_O = 10$ V, $R_L = 2$ k Ω	50	–	–	50	–	–	V/mV
V_O	Output Voltage Swing	$R_L = 10$ k Ω	± 12	–	–	± 12	–	–	V
		$R_L = 2$ k Ω	± 10	–	–	± 10	–	–	V
V_{CM}	Input Common Mode Voltage Range		± 11	+15 –12	–	± 11	+15 –12	–	V
CMRR	Common Mode Rejection Ratio	$R_S = 10$ k Ω	80	–	–	80	–	–	dB
PSRR	Supply Voltage Rejection Ratio	$R_S = 10$ k Ω	80	–	–	80	–	–	dB
I_S	Supply Current	Per Amplifier	–	–	2.8	–	–	2.8	mA

The Following Specifications Apply for $V_S = \pm 15$ V, -55° C $\leq T_A \leq 125^\circ$ C

V_{OS}	Input Offset Voltage	$R_S = 10$ k Ω Note 3	–	–	5.0	–	–	8.0	mV
$\Delta V_{OS}/\Delta T$	Average TC of Input Offset Voltage	$R_S = 10$ k Ω	–	10	–	–	10	–	μ V/ $^\circ$ C
I_{OS}	Input Offset Current	Notes 3, 4	–	–	20	–	–	20	nA
I_B	Input Bias Current	Notes 3, 4	–	–	50	–	–	50	nA
A_{VOL}	Large Signal Voltage Gain	$V_O = \pm 10$ V, $R_L = 2$ k Ω	25	–	–	25	–	–	V/mV
V_O	Output Voltage Swing	$R_L = 10$ k Ω	± 12	–	–	± 12	–	–	V
		$R_L = 2$ k Ω	± 10	–	–	± 10	–	–	V
CMRR	Common Mode Rejection Ratio	$R_S = 10$ k Ω	–	80	–	–	80	–	dB
PSRR	Supply Voltage Rejection Ratio	$R_S = 10$ k Ω	–	80	–	–	80	–	dB
I_S	Supply Current	Per Amplifier	–	–	3.4	–	–	3.4	mA

COMMERCIAL AND MILITARY

AC ELECTRICAL CHARACTERISTICS $V_S = \pm 15$ V, $T_A = 25^\circ$ C

SYMBOL	CHARACTERISTICS	CONDITIONS	μ AF77XA/AM			μ AF77XB/BM			μ AF77X			μ AF77XL			UNITS
			MIN	TYP	MAX	MIN	TYP	MAX	MIN	TYP	MAX	MIN	TYP	MAX	
SR	Slew Rate	(Fig. 1)		13			13			13			13	V/ μ s	
GBW	Gain Bandwidth Product	(Fig. 2)		3.0			3.0			3.0			3.0	MHz	
e_n	Equivalent Input Noise Voltage	$R_S = 100$ Ω , $f = 1000$ Hz		16			16			16			16	nV/ \sqrt Hz	
i_n	Equivalent Input Noise Current	$f = 1000$ Hz		0.01			0.01			0.01			0.01	pA/ \sqrt Hz	

NOTES:

1. Rating applies to ambient temperatures up to 70° C above $T_A = 70^\circ$ C. Derate linearly 6.3 mW/ $^\circ$ C for the metal can, 5.6 mW/ $^\circ$ C for the mini DIP and 8.3 mW/ $^\circ$ C for the DIP.
2. Unless otherwise specified the absolute maximum negative input voltage is equal to the negative power supply voltage.
3. I_B and I_{OS} are measured at $V_{CM} = 0$.
4. The input bias currents are junction leakage currents which approximately double for every 10° C increase in the junction temperature, T_J . Due to limited production test time, the input bias currents measured are correlated to junction temperature. In normal operation the junction temperature rises above the ambient temperature as a result of internal power dissipation, P_D . $T_J = T_A = \theta_{JA} P_D$ where θ_{JA} is the thermal resistance from junction to ambient. Use of a heat sink is recommended if input bias current is to be kept to a minimum.
5. Supply voltage rejection ratio is measured for both supply magnitudes increasing or decreasing simultaneously in accordance with common practice.

5

AC CHARACTERISTICS MEASUREMENT INFORMATION

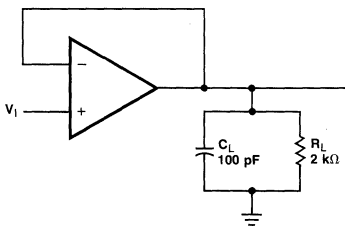

Fig. 1. Unity Gain Amplifier

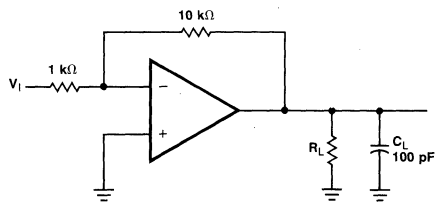

Fig. 2. Gain-of-10 Inverting Amplifier.

CONNECTION DIAGRAMS AND ORDERING INFORMATION

μ AF771

8-PIN METAL CAN
(TOP VIEW)

PACKAGE OUTLINE 5B 5S
PACKAGE CODE H H

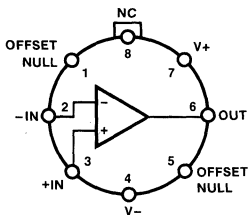

Note: Pin 4 connected to case.

ORDER INFORMATION

TYPE	PART NO.
μ AF771AM	μ AF771AHM
μ AF771BM	μ AF771BHM
μ AF771A	μ AF771AHC
μ AF771B	μ AF771BHC
μ AF771	μ AF771HC
μ AF771L	μ AF771LHC

8-PIN MINI DIP
(TOP VIEW)

PACKAGE OUTLINES 6T 9T
PACKAGE CODES R T

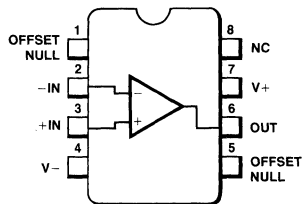

ORDER INFORMATION

TYPE	PART NO.
μ AF771AM	μ AF771ARM
μ AF771BM	μ AF771BRM
μ AF771A	μ AF771ARC
μ AF771B	μ AF771BRC
μ AF771	μ AF771RC
μ AF771L	μ AF771LRC
μ AF771A	μ AF771ATC
μ AF771B	μ AF771BTC
μ AF771	μ AF771TC
μ AF771L	μ AF771LTC

CONNECTION DIAGRAMS AND ORDERING INFORMATION (Cont.)

μ AF772

8-PIN METAL CAN
(TOP VIEW)

PACKAGE OUTLINE 5S 5B
PACKAGE CODE H H

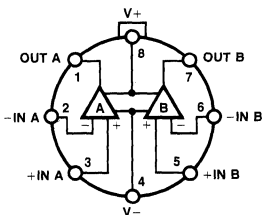

8-PIN MINI DIP
(TOP VIEW)

PACKAGE OUTLINES 6T 9T
PACKAGE CODES R T

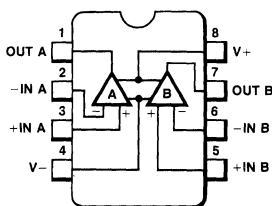

14-PIN DIP
(TOP VIEW)

PACKAGE OUTLINE 6A 9A
PACKAGE CODE D P

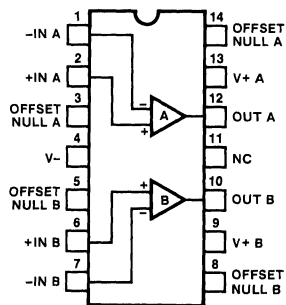

ORDER INFORMATION

TYPE	PART NO.
μ AF772AM	μ AF772AHM
μ AF772BM	μ AF772BHM
μ AF772A	μ AF772AHC
μ AF772B	μ AF772BHC
μ AF772	μ AF772HC
μ AF772L	μ AF772LHC

ORDER INFORMATION

TYPE	PART NO.
μ AF772AM	μ AF772ARM
μ AF772BM	μ AF772BRM
μ AF772A	μ AF772ARC
μ AF772B	μ AF772BRC
μ AF772	μ AF772RC
μ AF772L	μ AF772LRC
μ AF772A	μ AF772ATC
μ AF772B	μ AF772BTC
μ AF772	μ AF772TC
μ AF772L	μ AF772LTC

ORDER INFORMATION

TYPE	PART NO.
μ AF772AM	μ AF772ADM
μ AF772BM	μ AF772BDM
μ AF772A	μ AF772ADC
μ AF772B	μ AF772BDC
μ AF772	μ AF772DC
μ AF772L	μ AF772LDC
μ AF772A	μ AF772APC
μ AF772B	μ AF772BPC
μ AF772	μ AF772PC
μ AF772L	μ AF772LPC

μ AF774

14-PIN DIP
(TOP VIEW)

PACKAGE OUTLINE 6A 9A
PACKAGE CODE D P

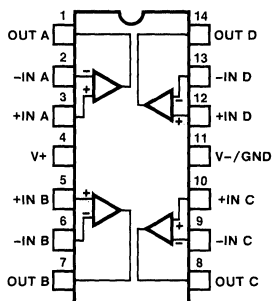

ORDER INFORMATION

TYPE	PART NO.
μ AF774AM	μ AF774ADM
μ AF774BM	μ AF774BDM
μ AF774A	μ AF774ADC
μ AF774B	μ AF774BDC
μ AF774	μ AF774DC
μ AF774L	μ AF774LDC
μ AF774A	μ AF774APC
μ AF774B	μ AF774BPC
μ AF774	μ AF774PC
μ AF774L	μ AF774LPC