



AGES  
适合8岁以上儿童



# 自装 太阳能概念屋

环保·教育·趣味

## DIY SOLAR ENERGY CONCEPT HOUSE

Environmental • Educational • Enjoyable

### 使用说明书 Assembly & Instruction



规格如有变更，恕不另行通知。  
实物可能与说明书上的图片有所不同。  
Specifications are subject to change without notice.  
Photos and illustrations may vary from actual product.

#### 警告：

窒息危险-含有细小物件  
不适合3岁以下的儿童使用

#### WARNING:

CHOKING HAZARD - small parts,  
Not for children under 3 years.



中国制造 MADE IN CHINA



科学·技术·工程·数学

## ◎ 产品介绍 Product Introduction: ◎

自装太阳能概念屋是一款教育性玩具，采用太阳能、电能双动力，儿童可通过两种不同的驱动方法的对比学习到太阳能的原理和作用，从小养成环保意识，探索绿色建筑的未来！







DIY solar concept house is an educational solar kit running with solar energy or battery power. Children will learn the principles and operation of solar energy by comparing the two different driving powers. It can cultivate their environmental protection consciousness & inspire their exploration interests in green architecture.

## ◎ 需要的工具(自备) Tool you may need(Not included): ◎

5号(AA)电池 Battery(AA)

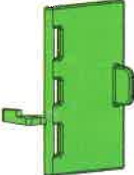
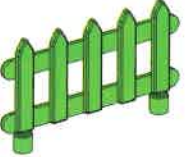

## ◎ 零件清单 Parts List: ◎

<p><b>P1</b> LED灯饰品01 LED light decoration 01</p>  <p>数量 Qty 1pc</p>	<p><b>P2</b> LED灯饰品02 LED light decoration 02</p>  <p>数量 Qty 1pc</p>	<p><b>P3</b> 窗子 Window</p>  <p>数量 Qty 6pc</p>
<p><b>P4</b> 喇叭筒 Megaphone</p>  <p>数量 Qty 1pc</p>	<p><b>P5</b> 风车叶 Windmill</p>  <p>数量 Qty 1pc</p>	<p><b>P6</b> 狗屋 Doghouse</p>  <p>数量 Qty 1pc</p>
<p><b>P7</b> 梯子 Ladder</p>  <p>数量 Qty 1pc</p>	<p><b>P8</b> 门 Door</p>  <p>数量 Qty 1pc</p>	<p><b>P9</b> 花园篱笆01 Garden Fence 01</p>  <p>数量 Qty 3pc</p>

P10 花园篱笆02 Garden Fence 02

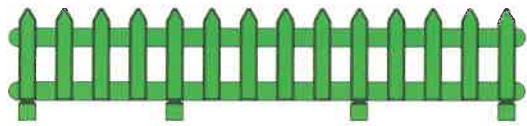

数量 Qty  
1pc

P11 花园篱笆03 Garden Fence 03

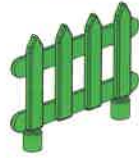

数量 Qty  
1pc

P12 烟囱盖 Chimney Cover



数量 Qty  
1pc

P13 房屋墙体01 House Wall 01

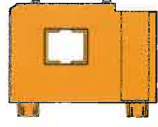

数量 Qty  
1pc

P14 房屋墙体02 House Wall 02

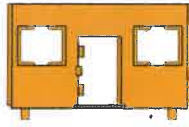

数量 Qty  
1pc

P15 房屋墙体03 House Wall 03

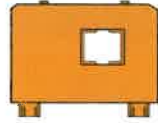

数量 Qty  
1pc

P16 房屋墙体04 House Wall 04



数量 Qty  
1pc

P17 屋顶 Roof



数量 Qty  
1pc

P18 房屋底座 House Base

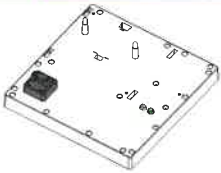

数量 Qty  
1pc

P19 螺丝 Screw



数量 Qty  
4pc

P20 带帽螺丝 Flanged tapping screw



数量 Qty  
4pc

P21 十字螺丝刀 Cross screwdriver



数量 Qty  
4pc

**警告(WARNING):**  
不要把电线和螺丝刀连接到电源上。  
Do not connect the wire and the screwdriver to the power supply.

装配 Assembly

步骤 STEP 1

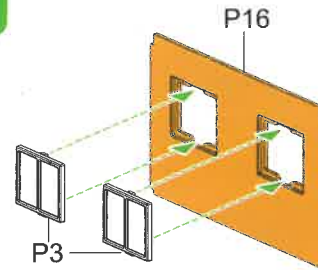

如图，将两个P3窗子安装到P16墙中。  
As shown, fix two P3 Windows into P16 Wall.

步骤 STEP 3

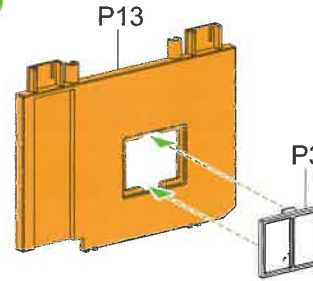

如图，将P3窗子安装到P13墙中。  
As shown, fix P3 Window into P13 Wall.

步骤 STEP 5

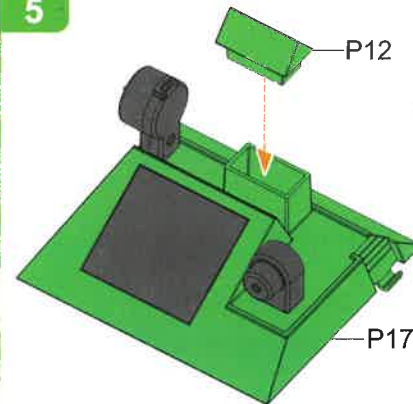

如图，将P12烟囱盖装到P17屋顶上。  
As shown, fix P12 Chimney onto P17 Roof.

步骤 STEP 2

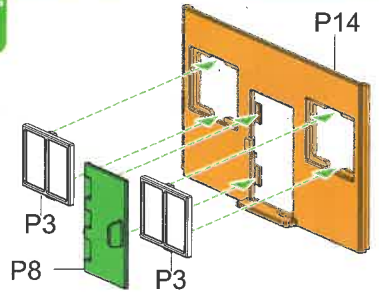

如图，先将两个P3窗子安装到P14墙中，再将P8门安装进P14墙中。  
As shown, fix two P3 Windows into P14 Wall, and then P8 Door into P14 Wall.

步骤 STEP 4

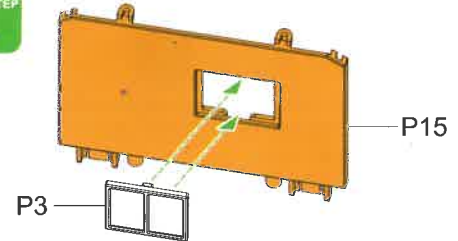

如图，将P3窗子安装到P15墙中。  
As shown, fix P3 Window into P15 Wall.

步骤 STEP 6

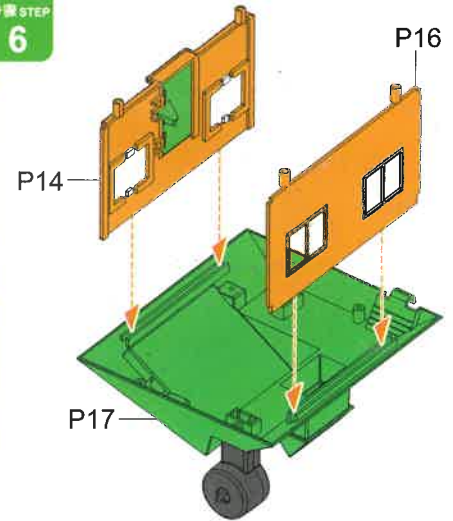

如图，将P14和P16墙安装到P17屋顶上。  
As shown, fix P14 and P16 Walls onto P17 Roof.

步骤 STEP  
7

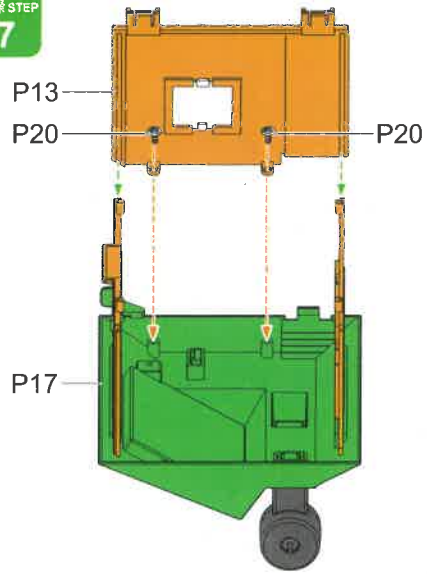

如图，将P13安装到P17屋顶，并用两颗P20螺丝锁紧。  
As shown, fix P13 Wall onto P17 Roof, and lock it with two P20 Screws.

步骤 STEP  
8

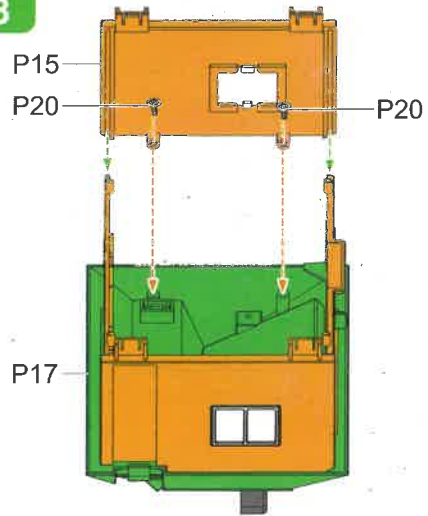

如图，将P15安装到P17屋顶，并用两颗P20螺丝锁紧。  
As shown, fix P15 Wall onto P17 Roof, and lock it with two P20 Screws.

步骤 STEP  
9

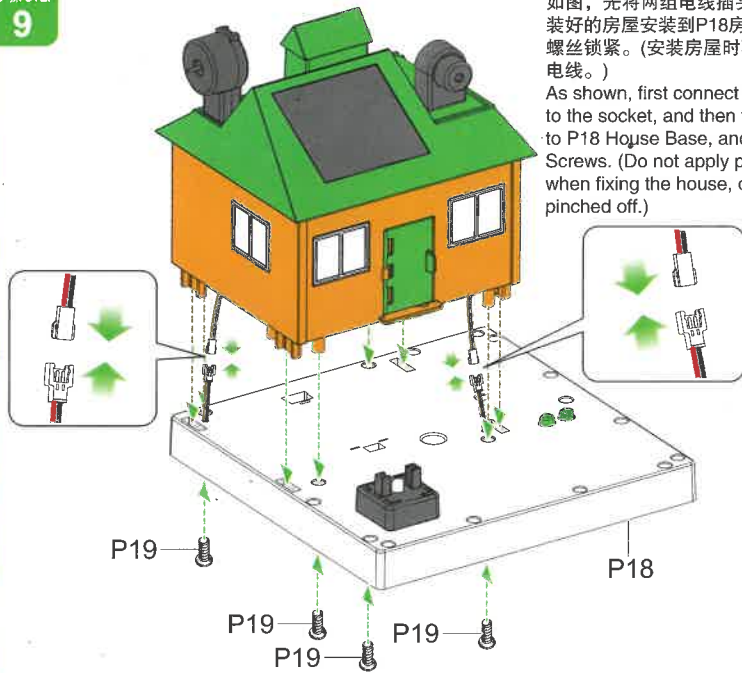

如图，先将两组电线插头与插座连接好，再将组装好的房屋安装到P18房屋底座上，并用四颗P19螺丝锁紧。(安装房屋时不要夹到电线，以免夹断电线。)  
As shown, first connect the two conductor plugs to the socket, and then fix the assembled house to P18 House Base, and lock it with four P19 Screws. (Do not apply pressure to the conductor when fixing the house, or the conductor may be pinched off.)

步骤 STEP  
10

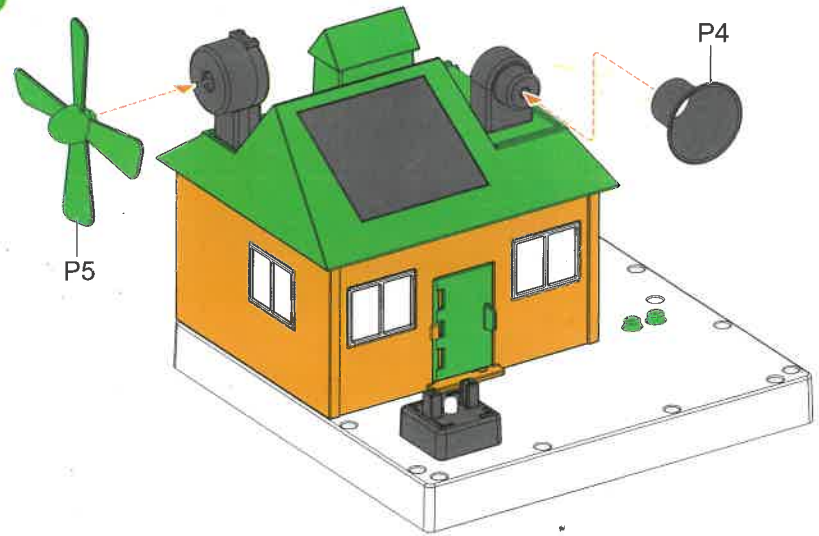

如图，将P4喇叭筒和P5风车叶安装到房屋上。  
As shown, fix P4 Megaphone and P5 Windmill to the house.

步骤 STEP  
11

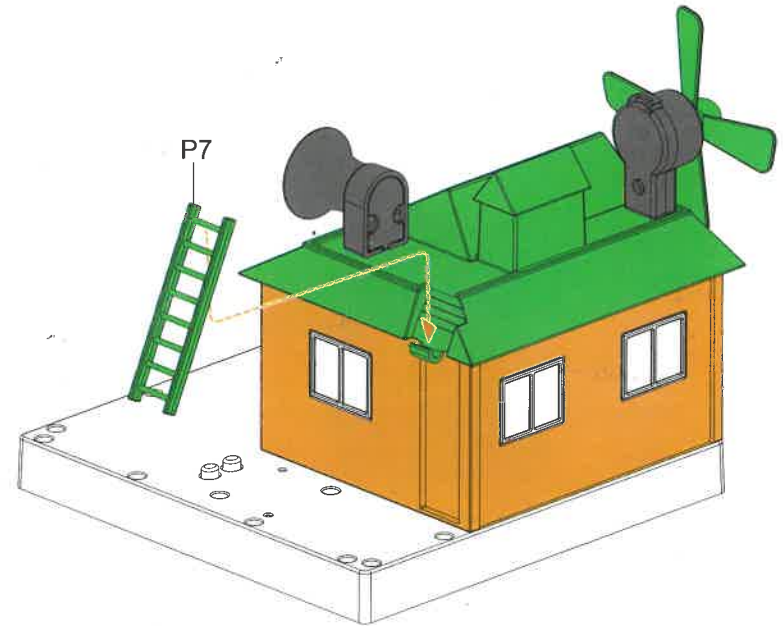

如图，将P7梯子安装到房屋上。  
As shown, fix P7 Ladder to the house.

步骤 STEP  
12

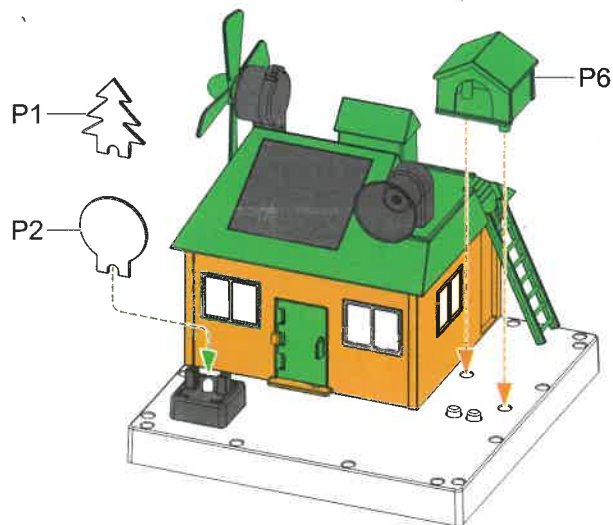

如图，先将组装完成的P6狗屋安装到房屋底盘上，再将(P1/P2) LED灯饰品其中一个配件安装到LED灯座上。  
As shown, the assembled P6 dog house is first installed on the chassis of the house, and then one of the (P1/P2) LED lamp accessories is mounted on the LED lamp holder.

步骤 STEP  
13

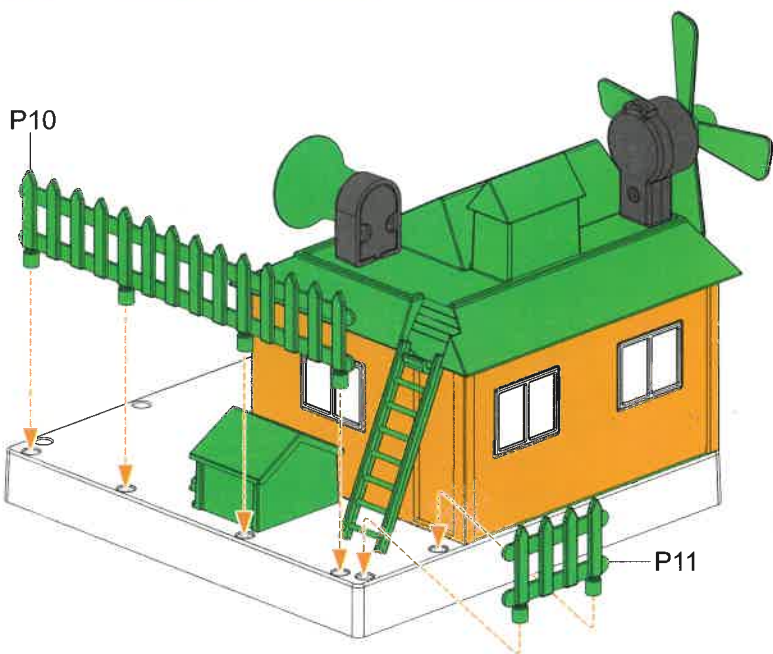

如图，将P10和P11花园篱笆安装到房屋底盘上。  
As shown, the P10 and P11 garden fences are mounted to the chassis of the house.

步骤 STEP  
14

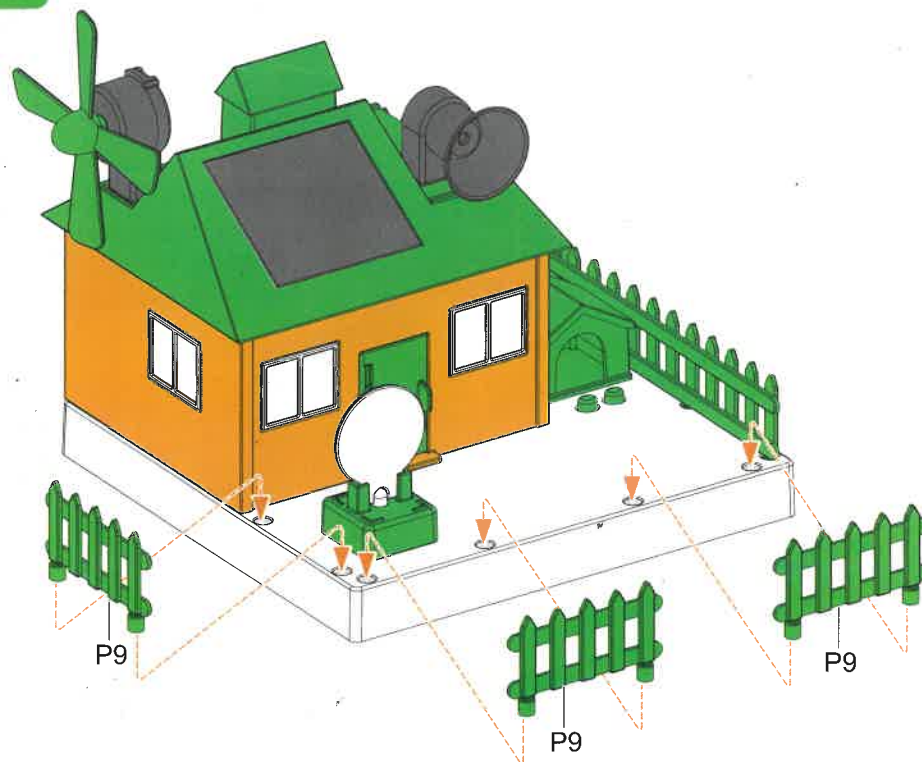

如图，将P9花园篱笆配件安装到房屋底盘上。  
As shown, fix P9 Garden Fence fittings to the house base.

⊙ 是时候开始玩了 It's time to have some FUN! ⊙

**1. 太阳能电池供电 Solar battery powered:**

- (1). 电池槽中不要放置电池，打开电源开关。
  - (2). 拿出放到太阳光直射处，在阳光普照下操作最佳。
  - (3). 太阳能屋子上风车开始转动，房屋内和LED灯座灯光亮起，再点下音乐开关，音乐喇叭发出音乐。
  - (4). 在室内请使用100W卤钨灯。本产品阴天，阴暗地方，荧光灯下将不能操作。
- (1). Remove the batteries in the battery tank, and turn on the power switch.
  - (2). Take it outside under sunlight directly, operating on sunny day will be best.
  - (3). The windmill on the solar house will start to rotate and lights in the house and at LED lamp holders will light up. Then turn on the music switch, and the music megaphone will play music.
  - (4). For indoor fun, use a 100 watt halogen light. The product will not run on a cloudy day, shaded locations, indirect sunlight, or under a fluorescent light.



## 2. 电池供电:

- (1). 用十字螺丝刀逆时针方向拧开电池盖上的螺丝，打开电池盖，按正确的极性将两节1.5V “AA” 电池安装到房屋底座的电池槽中，后盖上电池盖，用十字螺丝刀顺时针方向拧上螺丝。  
Loose the screws in the battery cover counterclockwise with a phillips screwdriver to open the battery cover, place two 1.5V AA batteries into the battery tank at the base of the house according to the correct polarity, and then put the battery cover back, and tighten the screws clockwise with a phillips screwdriver.

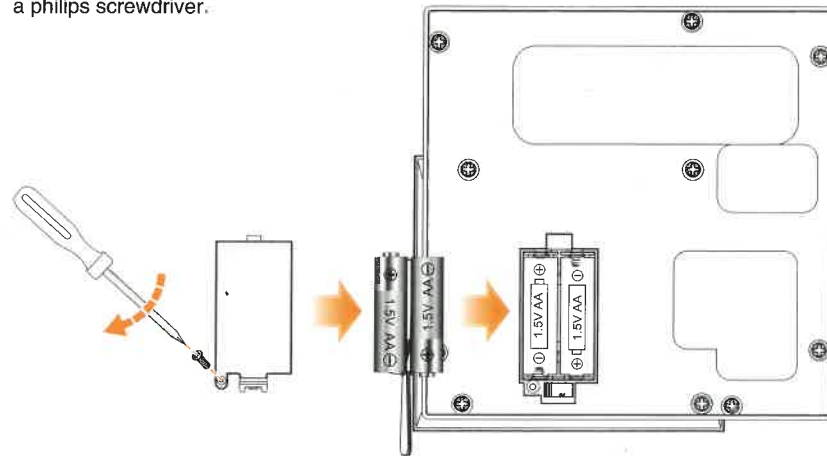

- (2). 打开电源开关，太阳能屋上风车开始转动，房屋内和LED灯座灯光亮起，再点下音乐开关，音乐喇叭发出音乐。  
Battery powered: turn on the switch, and the windmill on the solar house will start to rotate and lights in the house and at LED lamp holders will light up. Then turn on the music switch, and the music megaphone will play music.

