

**Model MA440** 400A AC Clamp Meter DMM

**Model MA443** True RMS 400 AC Clamp Meter DMM

**Model MA445** True RMS 400A AC/DC Clamp Meter DMM

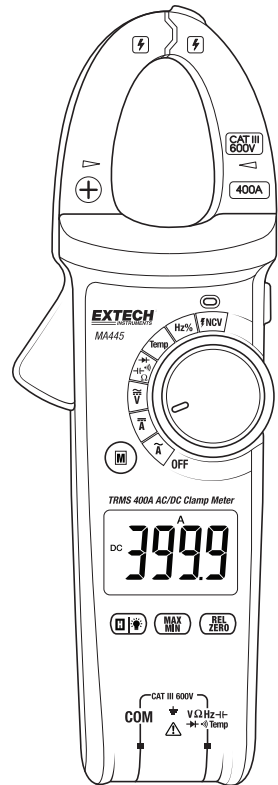
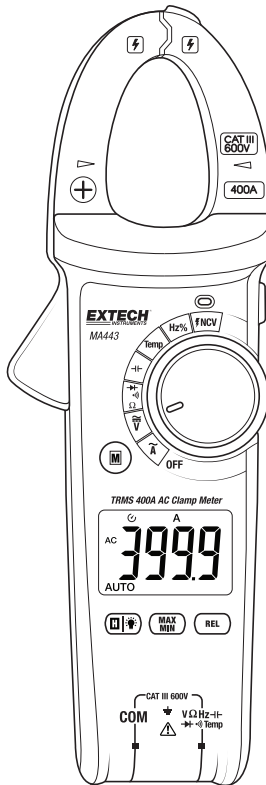
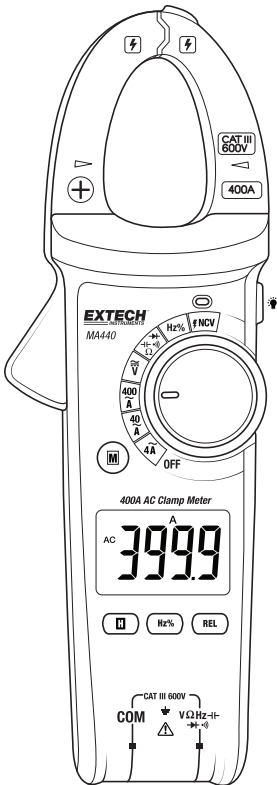

## Introduction

---

Thank you for selecting the Extech EX44x Series 400A Clamp Meter.

The **MA440** is a 400A AC Clamp meter with a total of 9 functions.

The **MA443** is a 400A True RMS AC Clamp meter that offers 10 functions including TRMS AC measurements and Type K Thermocouple

The **MA445** is a 400A AC/DC True RMS Clamp meter with 11 functions including DC Current, TRMS AC measurements, and Type K Thermocouple.

The MA44x series are hand-held, 4000 count clamp meters. This meter series measures AC/DC voltage, AC current, DC current (MA445), resistance, diode, continuity, capacitance, temperature (MA443 and MA445), frequency, and duty cycle. In addition, these meters offer Display hold, MIN-MAX (MA443 and MA445), Relative mode, NCV (non-contact voltage detection), and automatic power OFF.

In addition to the meter, the packaging includes Instructional documentation (Quick Start), Test Leads, K-type temperature probe (MA443 and MA445), batteries, and a pouch.

This device is shipped fully tested and calibrated and, with proper use, will provide years of reliable service. Please visit our website ([www.extech.com](http://www.extech.com)) to check for the latest version of this User Guide, Product Updates, Product Registration, and Customer Support.

## Safety

---

To ensure the safe operation and service of the meter, follow these instructions closely. Failure to observe warnings can result in severe personal injury or death.

These instruments are designed and produced in strict accordance with IEC/EN61010-1, IEC/EN 61010-2-032, and IEC/EN 61010-2-033, safety standards, and comply with the safety standard for double insulation, overvoltage CAT III 600V and pollution level 2. Please observe all operational and safety instructions otherwise the protection provided by instrument may be compromised.

These instruments conform to UL standard 61010-1, 61010-2-032, 61010-2-033; these instruments are certified to CSA standard C22.2 no. 61010-1, IEC standard 61010-2-032, and IEC standard 61010-2-033.

CAT III: Applicable to test and measuring circuits connected to the distribution section of a building's low voltage mains installation; before use of these instruments please observe and obey all safety instructions.



## WARNINGS













WARNINGS identify hazardous conditions and actions that could cause BODILY HARM or DEATH.

1. Before use, check the clamp meter and probe for damage or abnormal operation. Do not use the meter if probe insulation damage, meter display problems, abnormal meter functioning, etc. is observed.
2. Never use the meter with the battery compartment open or with the meter housing disassembled in any way; otherwise a risk of shock will exist.
3. When taking measurements, ensure that your hand and fingers are in the safe area behind the finger guard. Do not touch bare wire or connectors, unused input terminals, or the circuit under test to prevent electrical shock.
4. Before taking measurements, the function switch must be set to the correct position. To prevent damage to the meter, the function switch must not be turned while measurements are taking place.
5. Do not apply voltage 600V AC or DC or greater between the clamp meter terminals and ground. Failure to follow these instructions can cause electric shock and damage to the meter.
6. When measuring signals > 42V DC or > 30V AC rms please use caution as these levels can cause electrical shock.
7. Do not measure voltage or current higher than the allowable input; the function switch must be set to the maximum range position first when the range of the measured signal is unknown. Before measuring resistance, diode, and continuity please remove power to the circuit under test and discharge all capacitors.
8. When the low battery symbol is displayed, replaced the batteries promptly to ensure measurement precision. Remove batteries from the meter if the meter is to be stored longer than 60 days.
9. Do not service or modify the internal circuits of the meter. Qualified personnel must service the meter only.
10. Do not use the meter in flammable or explosive environments (gas or vapors). Do not use the meter in environments that exceed the operational temperature and humidity specifications. Do not use the meter in areas where a strong electromagnetic field is present.
11. To clean the meter, use only a soft damp cloth (neutral detergents only) to wipe the meter housing. Do not use abrasives or solvents. Do not clean the meter if it is powered on or connected to a circuit under test; always power the meter OFF and disconnect the test leads before cleaning.
12. Use only the test probes provided. Replace test probes with ones of the same rating or better. The test probes are to be used for mains measurements CAT III or CAT IV in accordance with IEC 61010-031 and shall have a voltage rating of at least the voltage of the circuit to be measured.
13. Individual protective equipment should be used if HAZARDOUS LIVE parts in the installation where measurements are to be carried out could be accessible.
14. If the equipment is used in a manner not specified by the manufacturer, the protection provided by the equipment may be impaired.
15. To reduce the risk of fire or electric shock, do not expose this product to rain or moisture.
16. Verify the meter operation by measuring a known voltage. If in doubt, have the meter serviced.
17. To avoid false readings that can lead to electric shock and injury, replace battery as soon as the low battery indicator appears.
18. De-energize the installation under test or wear suitable protective clothing when placing or removing the current clamp from a test setup.
19. Do not apply/remove the current clamp to/from UNINSULATED HAZARDOUS LIVE conductors which may cause electric shock, electric burn, or arc flash.

## CAUTIONS

CAUTIONS identify conditions and actions that could cause DAMAGE to the meter or equipment under test. Do not expose the meter to extremes in temperature or high humidity.

### Safety Symbols

	This symbol, adjacent to another symbol, indicates the user must refer to the manual for further information.
	Risk of electrical shock
	Alert beeper
	Equipment protected by double or reinforced insulation
	Diode symbol
	Capacitance
	Battery symbol
	Conforms to EU directives
	Complies with USA and Canada requirements
	AC measurement
	DC measurement
	Earth ground

# Description

## Meter Description

1. Transformer current jaws
2. Jaw opening trigger
3. M (Mode) button
4. Backlit LCD
5. Control buttons (see descriptions below)
6. COM negative input terminal
7. Positive input terminal
8. Function selector
9. NCV alert symbol
10. Backlight button (MA440) or Work Light button (MA443 and MA445)
11. NCV sensor

Note: Battery compartment is located on back of meter

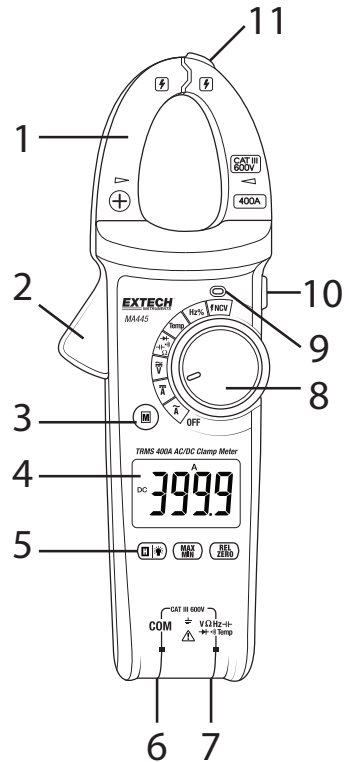







**Fig. 1 – Meter Description**

## Display Description

	Relative mode icon	Hz kHz MHz	Units of Frequency
<b>AC DC</b>	Alternating/Direct Current	<b>mV V</b>	Units of Voltage
	Negative readings	<b>nF μF mF</b>	Units of Capacitance
	Diode mode	<b>(EF) NCV</b>	Non-contact AC Voltage Detect
	Continuity mode	<b>Auto</b>	Automatic range mode
	Display Hold	<b>MAX MIN</b>	Maximum/Minimum readings
<b>Ω kΩ MΩ</b>	Units of resistance		Low Battery icon
	Auto Power OFF icon	<b>%</b>	Duty Cycle
	Danger: High Voltage	<b>OL</b>	Measurement overload

## Control Buttons

	<p>Mode button: Short presses to step through the mode options for the selected measurement function</p>
	<p>HOLD and Backlight button (MA443/MA445): Short press to freeze/unfreeze reading. Long press to turn backlight ON or OFF. Note that the backlight button is in the upper right side of the meter for the MA440 (see Side Button description below)</p>
	<p>HOLD button (MA440): Short press to freeze/unfreeze reading</p>
	<p>(MA443/MA445 only) Short press to enter the maximum measurement mode (LCD displays 'MAX'); press again to enter the minimum measurement mode ('MIN' is displayed). Long press to exit this mode. MAX/MIN is available on the AC Voltage/Current, Resistance, and Temperature MA445 functions only</p>
	<p>(MA445) Short press to store the displayed reading as a reference value. Subsequent measurements will be displayed as 'measurement minus reference value'. This feature applies to AC/DC voltage, AC current, resistance, and temperature modes only. Short press to exit. For DC current measurement mode, short press to zero the display; the LCD will show the delta symbol. Short press to exit this mode.</p>
	<p>(MA440/MA443) Short press to store the displayed reading as a reference value. Subsequent measurements will be displayed as 'measurement minus reference value'. This feature applies to AC/DC voltage, AC current, resistance, and temperature modes only. Short press to exit.</p>
	<p>(MA440 only) Short press to toggle frequency (Hz) and duty cycle (%) measurements for the Voltage and Hz switch positions. The MA443 and MA445 have a duty cycle mode accessible using the MODE button when the function dial is set to <b>Hz%</b>.</p>
<p><b>SIDE BUTTON</b> The button located on the upper right side of the meter is either for the LCD backlight (MA440: short press ON/OFF) or work light (MA443/MA445: Long press ON and short press OFF).</p>	

# Operation



## CAUTIONS

Read and understand all of the Safety statements listed in the safety section of this manual prior to use.

## Powering the Meter

1. Move the function switch to any position to power the meter. Check the batteries if the unit fails to power ON.
2. Move the function switch to the OFF position to remove power to the meter.
3. The meter has an Auto Power OFF feature (APO) where the meter switches OFF after 30 minutes (MA440) or 15 minutes (MA443/MA445) of inactivity. The MA443/MA445 models emit a warning tone prior to automatically switching off.

## Disable Auto Power OFF (MA443 and MA445)

To defeat the APO feature:

1. With the meter OFF, press and hold the **M (MODE)** button and, while continuing to hold the **M** button, turn the rotary switch to any position.
2. The meter will beep five times indicating that APO has been deactivated.
3. The Auto Power OFF function will now be disabled until the next cycle of power.
4. When APO is active, the APO symbol  is displayed. When APO is not active, the APO symbol is not displayed.

## AC Current Measurements



**WARNING:** Do not handle the meter above the finger/hand guard barrier.



**CAUTION:** Observe CAT III 600V with respect to Earth Ground for the Jaw.

1. Rotate the function switch to the AC Current position ( $\tilde{A}$  for MA443 and MA445 or  $4\tilde{A}/40\tilde{A}/400\tilde{A}$  for the MA440). For the MA440 start with the highest range setting (400A) and step down to lower ranges as needed, especially for signals that are of an unknown range.
2. The **A** and the **AC** symbols will appear on the display indicating AC Amperes (Amps). The display icon AUTO will also appear indicating automatic ranging.
3. Press the jaw trigger to open the clamp jaw.
4. Position the clamp around only one conductor. See Fig. 2 for correct and incorrect clamp technique.
5. Read the current in the display. The display will indicate the proper decimal point and value.

### NOTES:

To ensure maximum accuracy, place the conductor at the center of the clamp head, otherwise additional error ( $\pm 1.0\%$ ) may apply.

Do not release the trigger suddenly; the impact may lead to a change in readings since the Hall element is sensitive not only to magnetism but also to heat and mechanical stress to some extent.

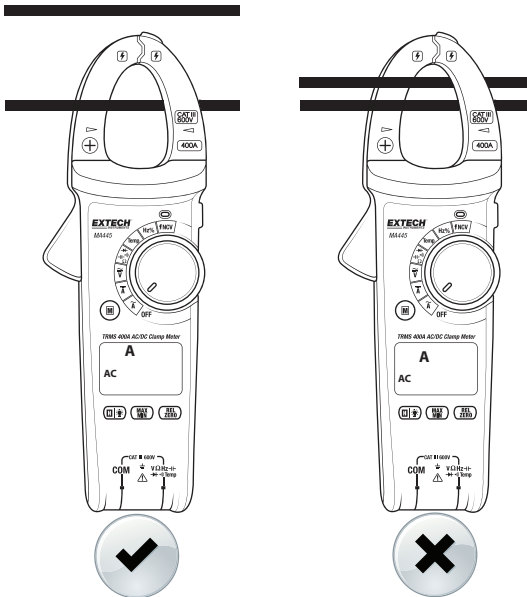

**Fig. 2 – Correct and Incorrect ACA Clamping**



## DC Current Measurements (MA445)



**WARNING:** Do not handle the meter above the finger/hand guard barrier.

**CAUTION:** Observe CAT III 600V with respect to Earth Ground for the Jaw.

**CAUTION:** Measure in the temperature range of 0 ~ 40°C only.

1. Rotate the function switch to the DC Current position  **$\overline{A}$** .
2. The **A** and the **DC** symbols will appear on the display indicating DC Amperes (Amps). The **AUTO** icon will also display indicating automatic ranging.
3. Zero any residual magnetism by pressing and holding the **REL ZERO** button with no conductor in the jaws. See Fig. 3 and Fig. 4
4. Press the jaw trigger to open the clamp jaw. Position the clamp around only one conductor. See Fig. 2 (previous section) for correct and incorrect clamping techniques.
5. Read the current in the display. The display will indicate the proper decimal point and value.

### NOTES:

To ensure maximum accuracy, place the conductor at the center of the clamp head, otherwise additional error ( $\pm 1.0\%$ ) may apply.

If the readings are positive, the current is flowing in a downward direction (faceplate to back of meter).

Do not release the trigger suddenly; the impact may lead to a change in readings since the Hall element is sensitive not only to magnetism but also to heat and mechanical stress to some extent.

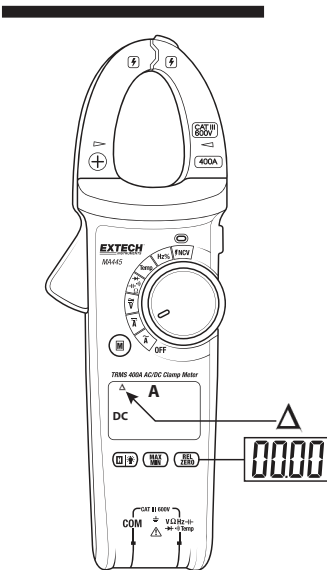

Fig. 3 – DCA Zero before measurement

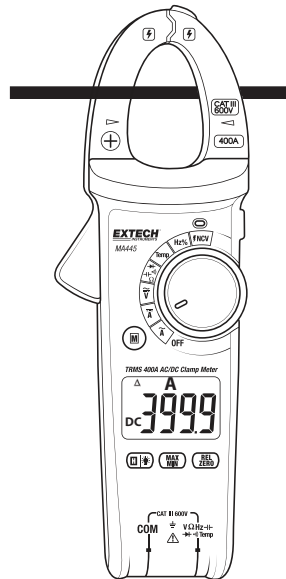

Fig. 4 – DCA Measurement

## AC and DC Voltage Measurements



**WARNING:** Do not apply > 600VAC/DC between the meter terminals and ground.

**CAUTION:** When connecting the test leads to the circuit or device under test, connect the black lead before the red lead; when removing the test leads, remove the red lead before the black lead.

1. Set the function select switch to the Voltage position  $\tilde{V}$ .
2. Use the **M** (Mode) button to select **AC** or **DC** Voltage.
3. Insert the black test lead banana plug into the negative (COM) jack and the red test lead banana plug into the positive (V) jack.
4. Touch the test probe tips to the circuit or under test. For DC measurements in the range of 400mV, use the Relative mode to zero the display before taking a measurement.
5. Read the voltage in the LCD. The display will indicate the proper decimal point and value.
6. Relative (REL) mode can be used to set a reference reading from which subsequent readings will be offset ( $reference\ reading - actual\ reading = displayed\ reading$ ). Long press the **REL** button to activate/deactivate the relative mode.
7. The MA440 can display the frequency (Hz) or duty cycle (%) of the measured voltage. Short press the **Hz %** button to toggle frequency and duty cycle readings. For the MA443/MA445 see the dedication section on Frequency for frequency and duty cycle.
8. The MA443 and MA445 record MAX and MIN readings. Short press the **MAX MIN** button to step through the MAX MIN readings. Long press the **MAX MIN** button to exit.
9. Short press the **H** button to freeze/unfreeze the displayed reading. Long press to activate/deactivate the display backlight.

**NOTES:** The MA440 displays **OL** when the input exceeds 1000V. The MA443/MA445 display  when the tested voltage is > 30V and sounds the buzzer when the voltage input is > 600V.

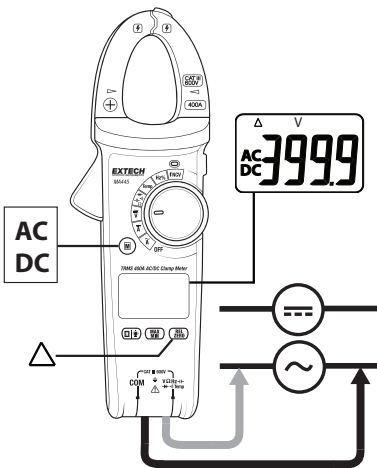

Fig. 5 MA443/MA445 Voltage test

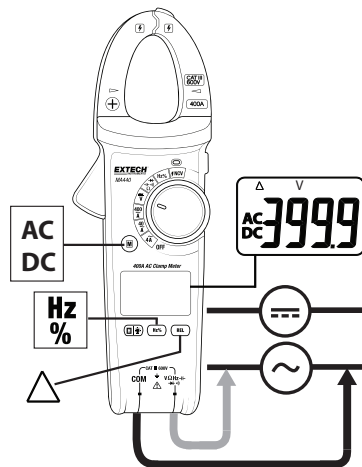

Fig. 6 – MA440 Voltage testing

## Resistance Measurements



**WARNING:** Please remove power to the circuit under test and discharge all capacitors before taking resistance or continuity measurements. The meter will display **OL** if the circuit under test is an open circuit or if the measurement exceeds the maximum range of the meter. Do not input a voltage  $>30V$  AC or DC.

1. Turn the function switch to the Resistance  $\Omega$  position.
2. Use the **M** (mode) button to select the ohm  $\Omega$  display symbol.
3. Insert the black test lead banana plug into the negative (COM) jack. Insert the red test lead banana plug into the positive ( $\Omega$ ) jack. See Fig. 7.
4. Touch the test probe tips across the circuit or part under test. It is best to disconnect one side of the part under test so that the rest of the circuit will not interfere with the resistance reading.
5. Read the resistance in the display. The display will indicate the proper decimal point and value.
6. The MAX-MIN function is available in this mode on the MA443 and MA445. Short press the **MAX MIN** button to step through MAX MIN readings. Long press to exit the mode.

### NOTES:

For low resistance measurements, the probe error ( $0.1\sim 0.2\Omega$ ) should be zeroed using the relative mode. Short circuit the test probes and press the REL button before taking measurements.

When measuring resistance  $>1M\Omega$  the meter may require several seconds to stability the displayed reading.

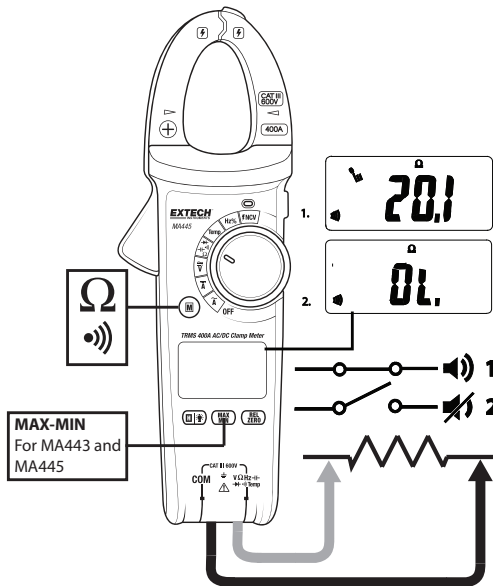

Fig. 7 – Resistance and Continuity Measurements

## Continuity Measurements



**WARNING:** Please remove power to the circuit under test and discharge all capacitors before taking resistance or continuity measurements. The meter will display **OL** if the circuit under test is an open circuit or if the measurement exceeds the maximum range of the meter. Do not input a voltage  $>30\text{V}$  AC or DC.

1. Turn the function switch to the Continuity position.
2. Use the **M** (mode) button to select the continuity display icon.
3. Insert the black lead banana plug into the negative (COM) jack. Insert the red test lead banana plug into the positive ( $\Omega$ ) jack. See Fig. 7 above.
4. Touch the test probe tips across the circuit or wire.
5. If the resistance is  $< 30\Omega$ , the meter will beep. If the resistance is  $> 60\Omega$ , the meter will not beep. If the resistance is between 30 and  $60\Omega$ , the meter will stop beeping at an unspecified point.

## Frequency Measurements



**WARNING:** Do not input voltages  $> 30\text{Vrms}$  when measuring frequency.

Turn the function switch to the **Hz%** position.

1. Insert the black lead banana plug into the negative (COM) jack. Insert the red test lead banana plug into the positive jack. See Fig. 8.
2. Touch the test probe tips across the circuit or component.
3. Read the Frequency measurement on the meter display.
4. For the MA443 and MA445, use the **M** (mode) button to view **Duty Cycle %**. For the MA440 use the **Hz%** button to view **Duty Cycle %**.

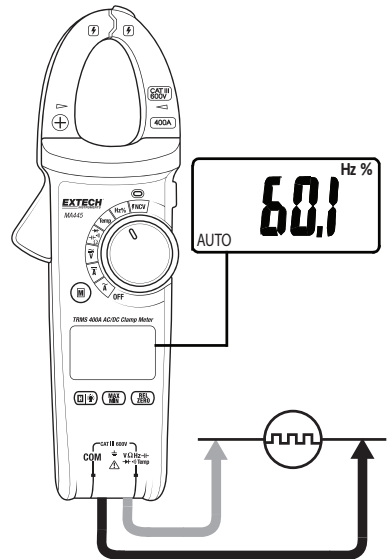

Fig. 8 – Frequency Measurements

## Capacitance Measurements



**WARNING:** Please remove power to the circuit under test and discharge all capacitors before taking capacitance measurements.

1. Turn the function switch to the  $\text{--}\text{||}\text{--}$  position.
2. Use the **M** (mode) button to select the capacitor display  $\text{--}\text{||}\text{--}$  icon if necessary.
3. Insert the black lead banana plug into the negative (COM) jack. Insert the red test lead banana plug into the positive jack. See Fig. 9.
4. Touch the test probe tips across the circuit or component.
5. Read the Capacitance measurement on the meter display. For readings  $> 400\mu\text{F}$ , several minutes may be required to obtain a stable reading.
6. Relative (REL) mode can be used to set a reference reading from which subsequent readings will be offset (reference reading – actual reading = displayed reading). Short press the REL button to activate/deactivate the relative mode.

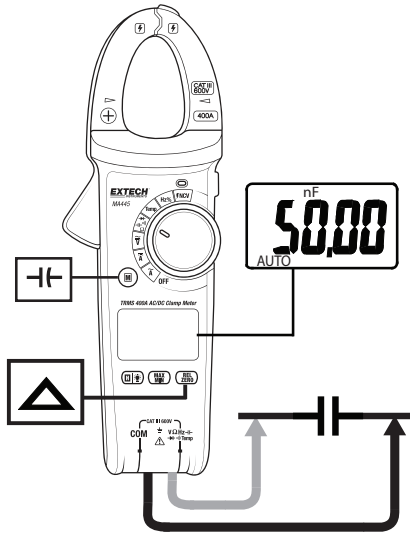

**Fig. 9 – Capacitance Measurements**

## Diode Test



**WARNING:** Please remove power to the circuit under test and discharge all capacitors before taking diode measurements. Do not input voltages > 30V DC or AC to the meter.

1. Turn the function switch to the position.
2. Use the **M** button to select the diode icon .
3. Insert the black test lead banana plug into the negative (COM) jack and the red test lead banana plug into the positive (V) jack. See Fig. 10.
4. Touch the test probes to the diode under test, in both polarity directions, one at a time.
5. Forward voltage will indicate 0.5 to 0.8V.
6. Reverse voltage will indicate "OL".
7. Shorted devices will indicate a reading close to '0' ohms and the meter will beep.
8. An open device will indicate 'OL' in both directions.

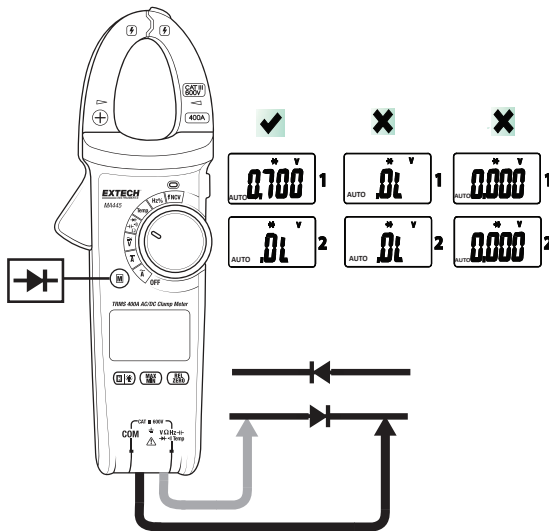

Fig. 10 – Diode Testing

## Temperature Measurements (MA443 and MA445)



**WARNING:** The supplied thermocouple is NOT rated for the entire specified temperature range of the meter. Please determine the range of temperature for the given application before attempting the use the supplied thermocouple. Obtain a different thermocouple if the range of the application exceeds the range of the supplied thermocouple.

Do not measure temperature if the meter is in an environment outside the range of 18~28°C.  
Do not input voltages > 30V DC or AC to the meter.

1. Turn the function switch to the **TEMP** position.
2. Use the **M** (mode) button to select degrees **C** or **F**.
3. Insert the supplied Type-K thermocouple into the negative (COM) jack and positive jack observing correct polarity.
4. Touch the temperature probe tip to the surface under test or simply hold the temperature in air to take an environmental reading.
5. Read the measured temperature on the meter display.

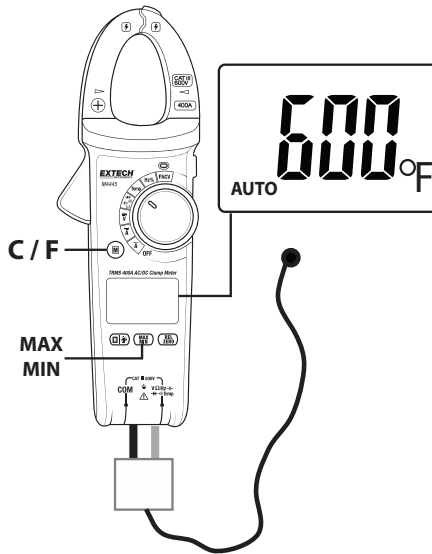

**Fig. 11** – Temperature Measurements

## Non-Contact Voltage-Detector (EF/NCV)

The area at the top of the clamp jaws is used for sensing AC voltage or an electromagnetic field.

For the MA400, when the electrical field is  $> 100V$  and the distance is  $< 10mm$ , the beeper will sound and the red LED lamp will light.

For the MA443 and MA445 when the electrical field is  $>100 V$  and the distance is  $< 10mm$ , the LCD will display dashes, the meter will beep, and the red LED lamp will light.

The NCV lamp flashes at the same rate as the beeper. The higher the field strength, the greater the number of dashes displayed (up to 5) and the faster the beep rate and lamp flashing.

When the sensed field is at highest levels, the meter's NCV lamp and beeper rate will become as one continuous light and tone.

If the meter does not react as described above to an AC voltage or electromagnetic field, there is still the possibility that a voltage or field is present. Please use caution.

1. Move the function switch to the **NCV** position.
2. In this mode, the MA443 and MA445 meter will display 'EF' (electromotive force) and the MA440 will display 'OL'. These indicate that the meter is in the NCV mode but is not sensing an AC Voltage or an electromagnetic field.
3. Place the meter near a source of electrical energy. The tip of the clamp offers the highest sensitivity.
4. Note the beeping, NCV lamp activation, and the dashes (MA443/MA445) when an AC Voltage or electromagnetic field is sensed.

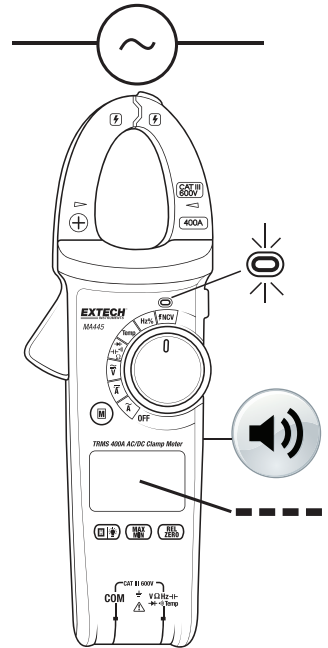

**Fig. 12** – Non-Contact Voltage Detection



## Maintenance



**WARNING:** To avoid electrical shock, disconnect the meter from any circuit and turn OFF the meter before opening the case. Do not operate with an open case.

### Cleaning and Storage

Periodically wipe the case with a damp cloth and mild detergent; do not use abrasives or solvents. If the meter is not to be used for 60 days or more, remove the batteries and store them separately.

### Battery Replacement

1. Remove the Phillips head screw at the back (near center) of the meter. See accompanying diagram.
2. Open the battery compartment.
3. Replace the three (3) 1.5V 'AAA' batteries observing correct polarity.
4. Re-assemble the meter before use.
5. Safety: Please dispose of batteries responsibly; never dispose of batteries in a fire, batteries may explode or leak; never mix battery types, install new batteries of the same type.

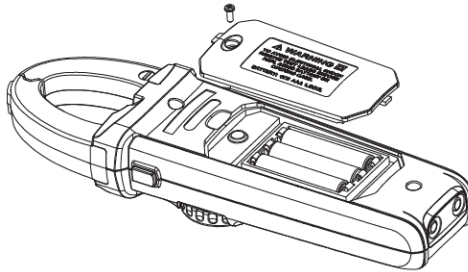

Never dispose of used batteries or rechargeable batteries in household waste.

As consumers, users are legally required to take used batteries to appropriate collection sites, the retail store where the batteries were purchased, or wherever batteries are sold.

**Disposal:** Do not dispose of this instrument in household waste. The user is obligated to take end-of-life devices to a designated collection point for the disposal of electrical and electronic equipment.

# Specifications

## Electrical Specifications

Accuracy is given as  $\pm$  (% of reading + least significant digits) at 23°C  $\pm$ 5°C with relative humidity  $\leq$  75%. Accuracy is specified for a period of one year after calibration.

- Temperature Coefficient is 0.1 x specified accuracy / °C, < 18°C (64.5°F), > 28°C (82.4°F)
- MA443/MA445 AC Functionality: ACV and ACA specifications are AC coupled, True RMS; For non-sinusoidal waveforms, additional accuracy Crest Factor (C.F.) considerations exist as detailed below:

Function	Range	Resolution	Accuracy (reading)	'OL' Protection
<b>AC Current</b>	4.000 A*	0.001 A	$\pm$ (2.5% + 30 digits)	400A
	40.00 A	0.01 A	$\pm$ (1.8% + 9d) MA440	
	400.0 A	0.1 A	$\pm$ (2.5% + 5d) MA443/MA445	
<p><i>*4A range on MA440 only</i>  <i>True RMS current (MA443 and MA445 only) applicable to 10%~100% of range</i>  <i>Frequency response: 50~60Hz (MA440 and MA443) and 40~400Hz (MA445)</i>  <i>MA443/MA445 AC Crest factor considerations:</i>  <i>a) Add 3% when wave factor is 1 ~ 2</i>  <i>b) Add 5% when wave factor is 2 ~ 2.5</i>  <i>c) Add 7% when wave factor is 2.5 ~ 3</i></p>				
<b>DC Current (MA445)</b>	40.00 A	0.01 A	$\pm$ (2.0% + 3 digits)	400A
	400.0 A	0.1 A		
<i>Use the ZERO function to null display (residual magnetism) before taking a measurement.</i>				
<b>AC Voltage</b>	4.000V	0.001V	$\pm$ (1.2% + 5 digits)	600V AC/DC
	40.00V	0.01V		
	400.0V	0.1V		
	600V	1V	$\pm$ (1.5% + 5 digits)	
<p><i>True RMS voltage (MA443 and MA445) applicable to 10%~100% of the range</i>  <i>Input Impedance: <math>\geq</math> 10M<math>\Omega</math>; Frequency Response: 50~60Hz (MA440 and MA443) and 40~400Hz (MA445)</i>  <i>MA443/MA445 AC Crest factor considerations:</i>  <i>a) Add 3% when wave factor is 1 ~ 2</i>  <i>b) Add 5% when wave factor is 2 ~ 2.5</i>  <i>c) Add 7% when wave factor is 2.5 ~ 3</i></p>				
<b>DC Voltage</b>	400.0mV	0.1mV	$\pm$ (1.0% + 5 digits)	600V AC/DC
	4.000V	0.001V	$\pm$ (0.8% + 1 digit)	
	40.00V	0.01V	$\pm$ (0.8% + 3 digits)	
	400.0V	0.1V		
	600V	1V	$\pm$ (1.0% + 3 digits)	
<i>Input Impedance: <math>\geq</math> 10M<math>\Omega</math></i>				

<b>Resistance</b>	400.0 Ω	0.1 Ω	± (1.2% + 2 digits)	600V AC/DC
	4.000k Ω	0.001k Ω	± (1.0% + 2 digits)	
	40.00k Ω	0.01k Ω		
	400.0k Ω	0.1k Ω	± (1.2% + 3 digits)	
	4.000M Ω	0.001M Ω		
	40.00M Ω	0.01M Ω	± (2.0% + 5 digits)	
<i>Open Circuit Voltage: Approx. 1.5V (MA440) and 0.4V (MA443 and MA445)</i>				
<b>Continuity</b>	400.0 Ω	0.1 Ω	± (1.2% + 2 digits)	600V AC/DC
<i>Continuity: Beeper ON &lt; 30Ω. Beeper OFF &gt;60Ω. Beeper unspecified &gt;30Ω and &lt;60Ω</i>				
<b>Diode</b>	4.000V	0.001V	Silicon PN junction 0.5 to 0.8V (typically)	600V AC/DC
<i>Open Circuit Voltage: Approx. 1.5V (MA440) and 3V (MA443 and MA445)</i>				
<b>Capacitance</b> (MA440)	50.00nF	0.01 nF	± (4.0% + 25 digits)	600V AC/DC
	500.0nF	0.1 nF	± (4.0% + 5 digits)	
	5.000 μF	0.001 μF		
	50.00 μF	0.01 μF		
	100.0 μF	0.1 μF		
<b>Capacitance</b> (MA443 and MA445)	40.00nF	0.01 nF	± (4.0% + 25 digits)	600V AC/DC
	400.0nF	0.1 nF	± (4.0% + 5 digits)	
	4.000 μF	0.001 μF		
	40.00 μF	0.01 μF		
	400.0 μF	0.1 μF	± (10%)	
	4.000 mF	0.001 mF		
	40.00 mF	0.01 mF	For reference only	
<b>Frequency (Hz)</b>	10Hz~1MHz	0.01Hz~1kHz	± (0.1% + 4 digits)	600V AC/DC
Sensitivity: MA440 (10Hz~1MHz): 200mVrms ≤ input amplitude ≤ 20Vrms MA443 and MA445 (≤100kHz): 100mVrms ≤ input amplitude ≤ 20Vrms (100kHz~1Mz): 200mVrms ≤ input amplitude ≤ 20Vrms.				
<b>Duty Cycle (%)</b>	0.1 ~ 99.9%	0.1%	± (2.5%)	600V AC/DC
Input amplitude: 500mVrms ≤ Input amplitude ≤ 20Vrms; Duty Cycle applies to ≤10kHz Square Wave Specified accuracy range: 10% ~ 90% range				

<b>TEMPERATURE</b> <b>(TYPE K Thermocouple)</b> (MA443 and MA445)	-40~40 °C	1° C	± (3.0% + 5 digits)*	600V AC/DC
	40~400 °C		± (1.0% + 3 digits)*	
	400~1000 °C		± (3.0% + 10 digits)*	
	-40~104 °F	1° F	± (3.0% + 10 digits)*	
	104~752°F		± (1.0% + 6 digits)*	
	752~1832°F			
*Does not include accuracy of the Type-K temperature probe				
<b>Non-Contact Voltage Detector (NCV)</b>	≥100Vrms; ≤10mm (0.4") LED displays dashes, beeper sounds, and NCV lamp lights			
<i>The tip of the meter offers optimum sensitivity</i>				

## General Specifications

<b>Display</b>	LCD 4000-count multi-function backlit LCD
<b>Polarity</b>	Automatic display of positive and negative polarity
<b>Over-range indication</b>	“OL” or “-OL” is displayed
<b>Conversion rate</b>	3 updates per second
<b>Clamp Sensor Type</b>	Coil induction (MA440); Hall Effect (MA443 and MA445)
<b>Test position error</b>	Additional error of $\pm 1.0\%$ of reading applies when the conductor under test is not positioned at the center of the clamp area
<b>Jaw Opening</b>	30mm diameter
<b>Electromagnetic field influence</b>	Unstable or inaccurate readings may be displayed if there is an electromagnetic field disturbance in the measurement environment
<b>Maximum Voltage</b>	600V AC/DC maximum applied to any terminal
<b>Low battery indication</b>	 is displayed
<b>Auto Power OFF</b>	After 30 minutes (MA440) or 15 minutes (MA443 and MA445) Hold <b>M</b> button while turning meter ON to disable APO (MA443 and MA445 only)

### Operating Temperature and Humidity

0~30°C (32~86°F); 80%RH maximum
30~40°C (86~104°F); 75%RH maximum
40~50°C (104~122°F); 45%RH maximum

### Storage Temperature and Humidity

-20°~60°C (-4°~140°F); 80%RH maximum (with battery removed)

### Operating Altitude

2000m (6562')

### Battery power

3 x 1.5V 'AAA' alkaline batteries

### Weight

265g (9.3 oz.) Including batteries

### Dimensions (W x H x D)

77 x 228 x 41mm (3.0 x 9.0 x 1.6")

### Safety Standards

Indoor use only; Complies with EN61010-1, EN61010-2-032, and EN61010-2-033; CAT III 600V; Pollution Degree 2



### Drop Protection

1m (approx. 3')

**Copyright © 2016 FLIR Systems, Inc.**

All rights reserved including the right of reproduction in whole or in part in any form