

Digital Storage Oscilloscope

GDS-1000B Series

PROGRAMMING MANUAL

GW INSTEK PART NO. Version 1.10, June 2015



ISO-9001 CERTIFIED MANUFACTURER

GW INSTEK

June 2015

This manual contains proprietary information which is protected by copyright. All rights are reserved. No part of this manual may be photocopied, reproduced or translated to another language without prior written consent of Good Will Corporation.

The information in this manual was correct at the time of printing. However, Good Will continues to improve products and reserves the right to change specifications, equipment, and maintenance procedures at any time without notice.

Windows is a registered trademark of Microsoft Corporation in the United States and other countries.

Good Will Instrument Co., Ltd.
No. 7-1, Jhongsing Rd., Tucheng Dist., New Taipei City 236, Taiwan.

Table of Contents

INTERFACE OVERVIEW	5
Interface Configuration	5
COMMAND OVERVIEW	16
Command Syntax	16
List of Commands in Functional Order	18
COMMAND DETAILS	27
Common Commands	29
Acquisition Commands	35
Autoscale Commands	42
Vertical Commands	43
Math Commands	49
Cursor Commands	58
Display Commands	69
Hardcopy Commands	73
Measure Commands	76
Measurement Commands	101
Reference Commands	109
Run Command	112
Stop Command	112
Single Command	112
Force Command	113
Timebase Commands	114
Trigger Commands	117
System Commands	134
Save/Recall Commands	135
Ethernet Commands	140
Label Commands	141
DVM Commands	145
Go_NoGo Commands	148

Data Logging Commands	154
Remote Disk Commands	158
A PPENDX.....	161
Error messages	161
I NDEX.....	165





INTERFACE OVERVIEW

This manual describes how to use the GDS-1000B's remote command functionality and lists the command details. The Overview chapter describes how to configure the GDS-1000B USB and Ethernet remote control interface.

Interface Configuration

Configure USB Interface

USB Configuration	PC side connector	Type A, host
	GDS-1000B side connector	Type B, device
	Speed	1.1/2.0
	USB Class	CDC (communications device class)

- Panel Operation
1. Press the Utility key. 
 2. Press I/O from the bottom menu. 
 3. Press *USB Device Port* from the side menu and select *Computer*. 
 4. Connect the USB cable to the rear panel device port. 

5. When the PC asks for the USB driver, select the USB driver included on the accompanying User Manual CD or download the driver from the GW Instek website, www.gwinstek.com, in the GDS-1000B Download section. The driver automatically sets the GDS-1000B as a serial COM port (Shown as VPO in the PORTS node).

USB Functionality Check

Terminal Application

Invoke a terminal application such as RealTerm.

Set the COM port, baud rate, stop bit, data bit, and parity accordingly.

To check the COM port number and associated port settings, see the Device Manager in the PC. For Windows 7:

Control panel → *Hardware and Sound* → *Device Manager*

Example: Configuring RealTerm:

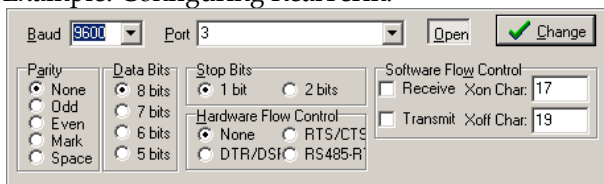

Functionality Check

Key in this query command via the terminal application.

`*idn?`



This should return the Manufacturer, Model number, Serial number, and Firmware version in the following format.

GW,GDS-1102B,PXXXXXX,V1.00

Configure the Ethernet Interface

Ethernet Configuration	MAC Address	Domain Name
	Instrument Name	DNS IP Address
	User Password	Gateway IP Address
	Instrument IP Address	Subnet Mask
		HTTP Port 80 (fixed)

Background The Ethernet interface is used for remote control using a socket server connection. For details, please see the Socket Server section on page 10.

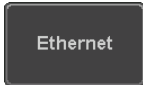
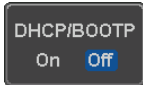
- Panel Operation**
1. Connect the Ethernet cable to the LAN port on the rear panel. 
 2. Press the *Utility* key. 
 3. Press *I/O* from the bottom menu. 
 4. Press *Ethernet* from the side menu. 
 5. Set *DHCP/BOOTP* to *On* or *Off* from the side menu. 



Note

IP addresses will automatically be assigned with DHCP/BOOTP set to on. For Static IP Addresses, DHCP/BOOTP should be set to off.

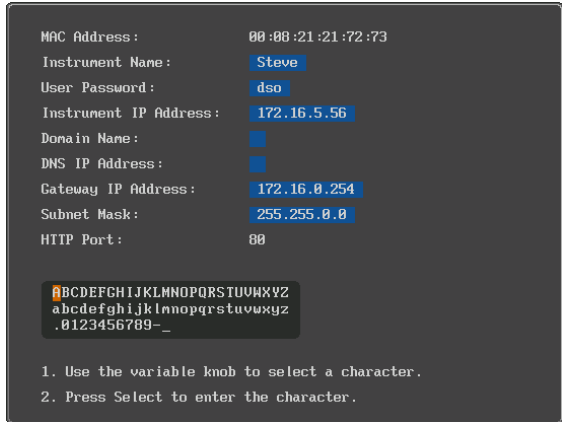

6. Use the *Up* and *Down* arrows on the side menu to navigate to each Ethernet configuration item.

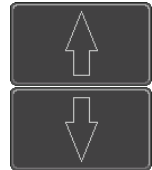

Items MAC Address, Instrument Name, User Password, Instrument IP Address, Domain Name, DNS IP Address, Gateway IP Address, Subnet Mask

Note: HTTP Port is fixed at 80.

7. Use the *Variable* knob to highlight a character and use the *Select* key to choose a character.

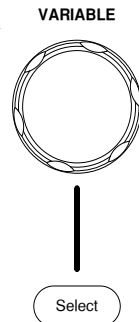

Press *Backspace* to delete a character.



Press *Save Now* to save the configuration. Complete will be displayed when successful.



Configure Socket Server

The GDS-1000B supports socket server functionality for direct two-way communication with a client PC or device over LAN. By default, the Socket Server is off.

Configure Socket Server

1. Configure the IP address for the GDS-1000B.

Page 8

2. Press the *Utility* key.



3. Press *I/O* from the bottom menu.

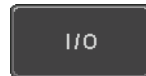

4. Press *Socket Server* from the side menu.

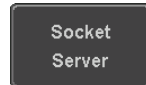

5. Press *Select Port* and choose the port number with the Variable knob.

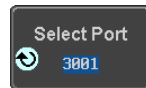

Range 1024~65535

6. Press *Set Port* to confirm the port number.

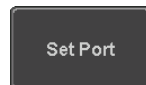

7. The Current Port icon will update to the new port number.



- Press *Server* and turn the socket server On.

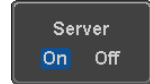

Socket Server Functionality Check

NI Measurement and Automation Explorer To test the socket server functionality, National Instruments Measurement and Automation Explorer can be used. This program is available on the NI website, www.ni.com.

- | | | |
|-----------|--|---|
| Operation | 1. Configure the IP address for the GDS-1000B. | Page 8 |
| | 2. Configure the socket port. | Page 10 |
| | 3. Start the NI Measurement and Automation Explorer (MAX) program. Using Windows, press: |  |

Start>All Programs>National Instruments>Measurement & Automation

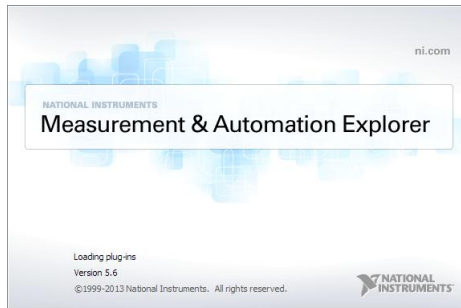

- From the Configuration panel access;

My System>Devices and Interfaces>Network Devices

- Right click *Network Devices* and select *Create New Visa TCP/IP Resource...*

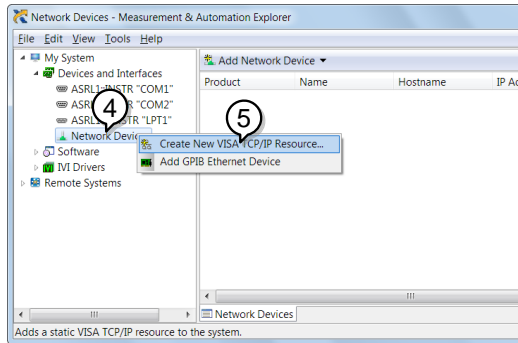

- Select *Manual Entry of Raw Socket* from the popup window.
- Click *Next*.

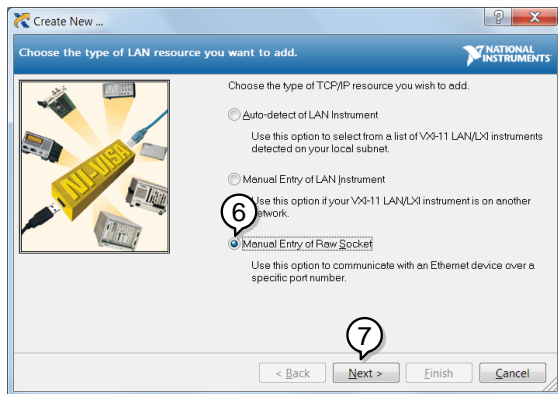

8. Enter the GDS-1000B's IP address and socket port number.
9. Click *Validate*.
10. A popup will appear to tell you if a VISA socket session was successfully created.
11. Click *Next*.

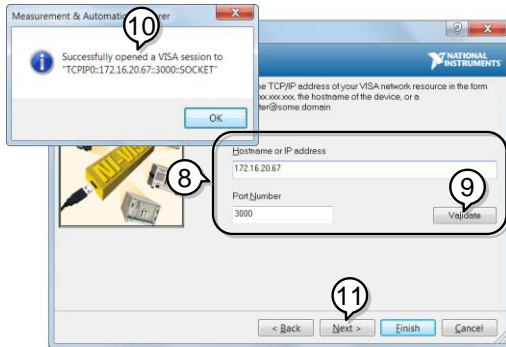

12. Choose an alias for the socket connection if you like.
13. Click *Finish* to finish the configuration.

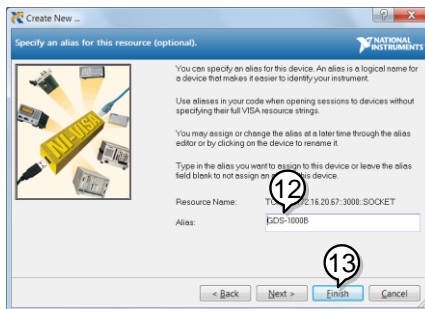

14. The GDS-1000B will now appear under Network Devices in the Configuration Panel.

Functionality
Check

15. Click the *Open Visa Test Panel* to send a remote command to the GDS-1000B.

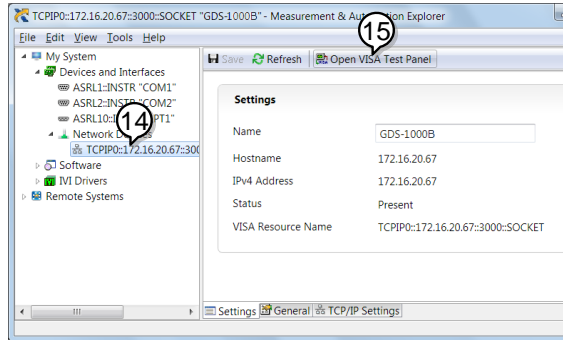

16. Click on the *Configuration* icon.

17. Select the *I/O Settings* tab.

18. Mark the *Enable Termination Character* checkbox. Make sure the termination character is a line feed (/n, value: xA).

19. Click *Apply Changes*.

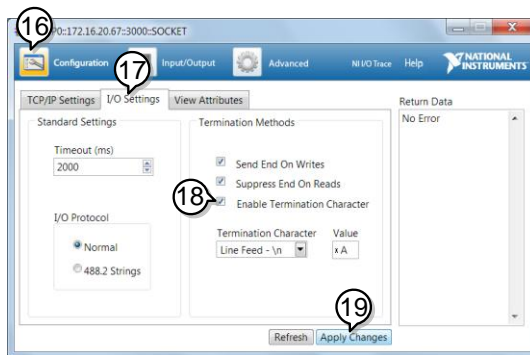

20. Click the *Input/Output* icon.
21. Make sure **IDN?* query is selected in the *Select or Enter Command* drop box.
22. Click on *Query*.
23. The manufacturer, model number, serial number and firmware version will be displayed in the buffer. For example:
GW,GDS-1102B,PXXXXXX,V1.00

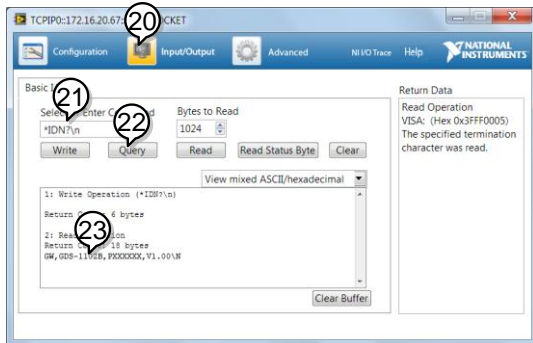

C **COMMAND OVERVIEW**

The Command overview chapter lists all GDS-1000B commands in functional order as well as alphabetical order. The command syntax section shows you the basic syntax rules you have to apply when using commands.

Command Syntax

- | | |
|---------------------|---|
| Compatible standard | <ul style="list-style-type: none"> • USB CDC_ACM compatible • SCPI, 1994 (partially compatible) |
|---------------------|---|

Command forms Commands and queries have two different forms, long and short. The command syntax is written with the short form of the command in capitals and the remainder (long form) in lower case.

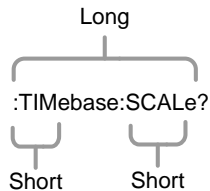

The commands can be written in capitals or lower-case, just so long as the short or long forms are complete. An incomplete command will not be recognized.

Below are examples of correctly written commands.

```

LONG :TiMebase:SCALe? :TiMEBASE:SCALE?
      :timebase:scale?
  
```

SHORT :TIM:SCAL?

:TIM:SCAL?

Command format :TIMbase:SCALE <NR3>LF 1: command header



1

2

3

4

2: single space

3: parameter

4: message terminator

Parameter	Type	Description	Example
	<Boolean>	boolean logic	0, 1
	<NR1>	Integers	0, 1, 2, 3
	<NR2>	floating point	0.1, 3.14, 8.5
	<NR3>	floating point with an exponent	4.5e-1, 8.25e+1
	<NRf>	any of NR1, 2, 3	1, 1.5, 4.5e-1
Message terminator	LF	line feed code	

Note Commands are non-case sensitive.

List of Commands in Functional Order

Common	*IDN?	29
	*LRN?	29
	*SAV	30
	*RCL	31
	*RST	31
	*CLS	31
	*ESE	31
	*ESR	32
	*OPC	33
	*SRE	33
*STB	34	
<hr/>		
Acquisition	:ACQuire:AVERage	35
	:ACQuire:MODE	36
	:ACQuire<X>:MEMory?	36
	:ACQuire:FILTer:SOURce	38
	:ACQuire:FILTer	39
	:ACQuire:FILTer:FREQuency	39
	:ACQuire:FILTer:TRACking	40
	:ACQuire<X>:STATe?	40
	:ACQuire:RECOrdlength	40
:HEADer	41	
<hr/>		
Autoscale	:AUTOSet	42
	:AUTORSET:MODE	42

Vertical Scale	:CHANnel<X>:BWLimit.....	43
	:CHANnel<X>:COUPling.....	44
	:CHANnel<X>:DESKew	44
	:CHANnel<X>:DISPlay	44
	:CHANnel<X>:EXPAnd	45
	:CHANnel<X>:IMPedance?	45
	:CHANnel<X>:INVert	46
	:CHANnel<X>:POSition	46
	:CHANnel<X>:PROBe:RATio	47
	:CHANnel<X>:PROBe:TYPe	47
	:CHANnel<X>:SCALe	47

Math	:MATH:DISP	49
	:MATH:TYPe	50
	:MATH:DUAL:SOURce<X>	50
	:MATH:DUAL:OPERator	50
	:MATH:DUAL:POSition.....	51
	:MATH:DUAL:SCALe.....	51
	:MATH:FFT:SOURce	52
	:MATH:FFT:MAG.....	52
	:MATH:FFT:WINDow	52
	:MATH:FFT:POSition	53
	:MATH:FFT:SCALe.....	53
	:MATH:FFT:HORizontal:SCALe.....	54
	MATH:FFT:HORizontal:POSition	54
	:MATH:DEFine	54
	MATHVAR?	55
	MATHVAR:VAR<X>	56
	:MATH:ADVanced:POSition	56
	:MATH:ADVanced:SCALe.....	56

Cursor	:CURSor:MODE	58
	:CURSor:SOURce.....	59
	:CURSor:HUNI	59
	:CURSor:HUSE	60
	:CURSor:VUNI	60

	:CURSor:VUSE	61
	:CURSor:DDT	61
	:CURSor:H1Position	61
	:CURSor:H2Position	62
	:CURSor:HDELta	62
	:CURSor:V1Position.....	62
	:CURSor:V2Position.....	63
	:CURSor:VDELta	63
	:CURSor:XY:RECTangular:X:POSition<X>	63
	:CURSor:XY:RECTangular:X:DELta	64
	:CURSor:XY:RECTangular:Y:POSition<X>	64
	:CURSor:XY:RECTangular:Y:DELta	65
	:CURSor:XY:POLar:RADIUS:POSition<X>	65
	:CURSor:XY:POLar:RADIUS:DELta	65
	:CURSor:XY:POLar:THETA:POSition<X>	66
	:CURSor:XY:POLar:THETA:DELta.....	66
	:CURSor:XY:PRODuct:POSition<X>	66
	:CURSor:XY:PRODuct:DELta	67
	:CURSor:XY:RATio:POSition<X>.....	67
	:CURSor:XY:RATio:DELta	67
<hr/>		
Display	:DISPlay:INTensity:WAVEform.....	69
	:DISPlay:INTensity:GRATICule	69
	:DISPlay:INTensity:BACKLight	70
	:DISPlay:INTensity:BACKLight:AUTODim:ENable	70
	DISPlay:INTENSITY:BACKLight:AUTODim:TIME	70
	:DISPlay:PERSistence	71
	:DISPlay:GRATICule	71
	:DISPlay:WAVEform	72
	:DISPlay:OUTPut	72

Hardcopy	:HARDcopy:START	73
	:HARDcopy:MODE	73
	:HARDcopy:PRINTINKSaver	74
	:HARDcopy:SAVEINKSaver	74
	:HARDcopy:SAVEFORMat	74
	:HARDcopy:ASSIGN	75
Measure	:MEASure:GATing	77
	:MEASure:SOURce	77
	:MEASure:METHod	78
	:MEASUrement:REFLevel:PERCent:HIGH	78
	:MEASUrement:REFLevel:PERCent:LOW	79
	:MEASUrement:REFLevel:PERCent:MID	79
	:MEASUrement:REFLevel:PERCent:MID2	79
	:MEASure:FALL	80
	:MEASure:FOVShoot	80
	:MEASure:FPReshoot	81
	:MEASure:FREQuency	81
	:MEASure:NWIDth	82
	:MEASure:PDUTy	82
	:MEASure:PERiod	83
	:MEASure:PWIDth	83
	:MEASure:RISe	84
	:MEASure:ROVShoot	84
	:MEASure:RPReshoot	85
	:MEASure:PPULSE	86
	:MEASure:NPULSE	86
	:MEASure:PEDGE	87
	:MEASure:NEDGE	87
	:MEASure:AMPlitude	88
	:MEASure:MEAN	88
	:MEASure:CMEan	89
	:MEASure:HIGH	90
	:MEASure:LOW	90
:MEASure:MAX	91	

	:MEASure:MIN	91
	:MEASure:PK2PK	92
	:MEASure:RMS	92
	:MEASure:CRMS.....	93
	:MEASure:AREa	94
	:MEASure:CARea	94
	:MEASure:FRRDelay	95
	:MEASure:FRFDelay	95
	:MEASure:FFRDelay	96
	:MEASure:FFFDelay.....	97
	:MEASure:LRRDelay	97
	:MEASure:LRFDelay.....	98
	:MEASure:LFRDelay.....	98
	:MEASure:LFFDelay.....	99
	:MEASure:PHase.....	100
<hr/>		
Measurement	:MEASUrement:MEAS<X>:SOURCE<X>.....	101
	:MEASUrement:MEAS<X>:TYPE.....	102
	:MEASUrement:MEAS<X>:STATE	102
	:MEASUrement:MEAS<X>:VALue	103
	:MEASUrement:MEAS<X>:MAXimum	104
	:MEASUrement:MEAS<X>:MEAN	105
	:MEASUrement:MEAS<X>:MINimum	105
	:MEASUrement:MEAS<X>:STDdev	106
	:MEASUrement:STATIstics:MODE	107
	:MEASUrement:STATIstics:WEIghting	107
	:MEASUrement:STATIstics	108
<hr/>		
Reference	:REF<X>:DISPlay	109
	:REF<X>:TIMebase:POSition	109
	:REF<X>:TIMebase:SCALE	110
	:REF<X>:OFFSet.....	110
	:REF<x>:SCALE	111
<hr/>		
Run	:RUN	112

Stop	:STOP	112
<hr/>		
Single	:SINGle.....	112
<hr/>		
Force	:FORCe.....	113
<hr/>		
Timebase	:TIMebase:EXPand	114
	:TIMebase:POSition	114
	:TIMebase:SCALe.....	114
	:TIMebase:MODE	115
	:TIMebase:WINDow:POSition	115
	:TIMebase:WINDow:SCALE	116
<hr/>		
Trigger	:TRIGger:FREQUency.....	118
	:TRIGger:TYPe.....	118
	:TRIGger:SOURce	119
	:TRIGger:COUPlE.....	119
	:TRIGger:NREJ	119
	:TRIGger:MODE.....	120
	:TRIGger:HOLDoff.....	120
	:TRIGger:LEVel.....	120
	:TRIGger:HLEVel.....	121
	:TRIGger:LLEVel.....	121
	:TRIGger:EDGe:SLOP	122
	:TRIGger:DELaY:SLOP	122
	:TRIGger:DELaY:TYPe	123
	:TRIGger:DELaY:TIME.....	123
	:TRIGger:DELaY:EVENt.....	123
	:TRIGger:DELaY:LEVel	124
	:TRIGger:PULSEWidth:POLarity.....	124
	:TRIGger:RUNT:POLarity	125
	:TRIGger:RUNT:WHEn	125
	:TRIGger:RUNT:TIME	126
:TRIGger:RISEFall:SLOP.....	126	
:TRIGger:RISEFall:WHEn	126	

	:TRIGger:RISEFall:TIME	127
	:TRIGger:VIDeo:TYPe	127
	:TRIGger:VIDeo:FIELD	128
	:TRIGger:VIDeo:LINE	129
	:TRIGger:VIDeo:POLarity	129
	:TRIGger:PULSe:WHEn	129
	:TRIGger:PULSe:TIME	130
	:TRIGger:TIMEOut:WHEn.....	130
	:TRIGger:TIMEOut:TIMER	131
	:TRIGger:ALTErnate	131
	:TRIGger:STATe	131
	:TRIGger:EXTErNal:PROBE:TYPe.....	132
	:TRIGger:EXTErNal:PROBE:RATio	133
<hr/>		
System	:SYSTem:LOCK	134
commands	:SYSTem:ERRor	134
<hr/>		
Save/Recall	:RECALL:SETUp	135
	:RECALL:WAVEform	135
	:SAVE:IMAGe	136
	:SAVE:IMAGe:FILEFormat.....	136
	:SAVE:IMAGe:INKSaver.....	137
	:SAVE:SETUp	137
	:SAVE:WAVEform.....	138
	:SAVE:WAVEform:FILEFormat	139
<hr/>		
Ethernet	:ETHERnet:DHCP	140
Commands		
<hr/>		
Label Commands	:CHANnel<X>:LABel.....	141
	:CHANnel<X>:LABel:DISPlay.....	142
	:REF<X>:LABel	142
	:REF<X>:LABel:DISPlay	143
	:SET<X>:LABel	144

DVM Commands	:DVM:STATE	145
	:DVM:SOURce	145
	:DVM:MODE.....	146
	:DVM:VALue	146

Go-NoGo	:GONogo:CLEar.....	148
Commands	:GONogo:EXECute	148
	:GONogo:FUNcTion.....	149
	:GONogo:NGCount.....	149
	:GONogo:NGDefine.....	149
	:GONogo:SOURce.....	150
	:GONogo:VIOLation.....	150
	:GONogo:SCRipt	150
	:TEMPlate:MODE	151
	:TEMPlate:MAXimum.....	151
	:TEMPlate:MINimum	151
	:TEMPlate:POSition:MAXimum.....	152
	:TEMPlate:POSition:MINimum	152
	:TEMPlate:SAVe:MAXimum	152
	:TEMPlate:SAVe:MINimum	153
	:TEMPlate:TOLerance.....	153
	:TEMPlate:SAVe:AUTO.....	153

Data Logging	:DATALOG:STATE	154
Commands	:DATALOG:SOURce	155
	:DATALOG:SAVe	155
	:DATALOG:INTerval	156
	:DATALOG:DURation.....	157

Remote Disk	:REMOTEDisk:IPADdRes	158
Commands	:REMOTEDisk:PATHName	158
	:REMOTEDisk:USERName	159
	:REMOTEDisk:PASSWord	159
	:REMOTEDisk:MOUNT.....	159
	:REMOTEDisk:AUTOMount.....	160

C COMMAND DETAILS

The Command details chapter shows the detailed syntax, equivalent panel operation, and example for each command. For the list of all commands, see page18.

Common Commands	29
Acquisition Commands	35
Autoscale Commands	42
Vertical Commands	43
Math Commands	49
Cursor Commands	58
Display Commands	69
Hardcopy Commands	73
Measure Commands	76
Measurement Commands	101
Reference Commands	109
Run Command	112
Stop Command	112
Single Command	112
Force Command	113
Timebase Commands	114
Trigger Commands	117
System Commands	134
Save/Recall Commands	135
Ethernet Commands	140
Label Commands	141
DVM Commands	145
Go_NoGo Commands	148
Data Logging Commands	154

Remote Disk Commands 158

Common Commands

*IDN?	29
*LRN?	29
*SAV	30
*RCL	31
*RST	31
*CLS	31
*ESE	31
*ESR	32
*OPC	33
*SRE	33
*STB	34

*IDN?



Description Returns the manufacturer, model, serial number and version number of the unit.

Syntax *IDN?

Example *IDN?
GW,GDS-1074B,PXXXXXX,V1.XX

*LRN?

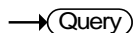

Description Returns the oscilloscope settings as a data string.

Syntax *LRN?

Example *LRN?
>;TYPE EDGE;SOURCE CH1;COUPLE AC;NREJ
OFF;REJECT OFF;MODE AUTO;HOLDoff 4.000e-
08;LEVELH -2.000E-04;LEVEL ?;EDGE:SLOP
RISE;DELAY:TYPE TIME;DELAY:TIME
0.000;DELAY:EVENT 1;DELAY:LEVEL ?;DELAY:SLOP
RISE;PULSEWidth:POLarity POSITIVE;RUNT:POLarity

```

POSITIVE;RUNT:WHEn THAN;RUNT:TIME
0.000;RISEFall:SLOP RISE;RISEFall:WHEn
THAN;RISEFall:TIME 0.000;VIDeo:TYPe
NTSC;VIDeo:FIELD FIELD1;VIDeo:LINE
1;VIDeo:POLarity NEGATIVE;PULSe:WHEn
THAN;PULSe:TIME 0.000;ALTErnate
OFF;EXTErnal:PRObe:TYPe
VOLTAGE;EXTErnal:PRObe:RATio
1.000e+00;:REF1:DISPlay ON;TIMEbase:POSition
0.000E+00;SCALE 5.000E-04;OFFSet 4.000E+00;SCALE
2.000E+00;:REF2:DISPlay OFF;TIMEbase:POSition
0.000E+00;SCALE 5.000E-04;OFFSet 3.840E+00;SCALE
2.000E+00;:REF3:DISPlay OFF;TIMEbase:POSition
0.000E+00;SCALE 2.000E-04;OFFSet 0.000E+00;SCALE
5.000E-01;:REF4:DISPlay OFF;TIMEbase:POSition
0.000E+00;SCALE 2.000E-04;OFFSet 0.000E+00;SCALE
5.000E-
01;:CHANnel1:LAbel ;;CHANnel2:LAbel ;;REF1:LAbel ;
:REF2:LAbel ;;REF3:LAbel ;;REF4:LAbel ;;SET1:LAbel ;;
SET2:LAbel ;;SET3:LAbel ;;SET4:LAbel ;;SET5:LAbel ;;S
ET6:LAbel ;;SET7:LAbel ;;SET8:LAbel ;;SET9:LAbel ;;SE
T10:LAbel ;;SET11:LAbel ;;SET12:LAbel ;;SET13:LAbel
;;SET14:LAbel ;;SET15:LAbel ;;SET16:LAbel ;;SET17:LA
bel ;;SET18:LAbel ;;SET19:LAbel ;;SET20:LAbel ;;CHA
Nnel1:LAbel:DISPlay OFF;:CHANnel2:LAbel:DISPlay
OFF;:REF0:LAbel:DISPlay OFF;:REF1:LAbel:DISPlay
OFF;:REF2:LAbel:DISPlay OFF;:REF3:LAbel:DISPlay
OFF
    
```

***SAV**

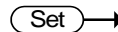

Description	Saves the current panel settings to the selected memory number(setup 1 ~ 20).
Syntax	*SAV {1 2 3 ... 20}
Example	*SAV 1 Saves the current panel settings to Set 1.

***RCL**

Set →

Description	Recalls a set of panel settings.
Syntax	*RCL {1 2 3 ... 20}
Example	*RCL 1 Recalls the selected setup from Set 1.

***RST**

Set →

Description	Resets the GDS-1000B (recalls the default panel settings).
Syntax	*RST

***CLS**

Set →

Description	Clears the error queue.
Syntax	*CLS

***ESE**

Set →

→ Query

Description	Sets or queries the Standard Event Status Enable register.		
Syntax	*ESE <NR1>		
Query Syntax	*ESE?		
Return parameter	<NR1>	0~255	

Bit Weight	Bit#	Weight	Event	Description
	0	1	OPC	Operation Complete Bit
	1	2	RQC	Not used
	2	4	QYE	Query Error
	3	8	DDE	Device Error

	4	16	EXE	Execution Error
	5	32	CME	Command Error
	6	64	URQ	User Request
	7	128	PON	Power On

Example *ESE?
>4
Indicates that there is a query error.

***ESR**



Description Queries the Standard Event Status (Event) register. The Event Status register is cleared after it is read.

Query Syntax *ESR?

Return parameter <NR1> 0~255

Bit Weight	Bit#	Weight	Event	Description
	0	1	OPC	Operation Complete Bit
	1	2	RQC	Not used
	2	4	QYE	Query Error
	3	8	DDE	Device Error
	4	16	EXE	Execution Error
	5	32	CME	Command Error
	6	64	URQ	User Request
	7	128	PON	Power On

Example *ESR?
>4
Indicates that there is a query error.



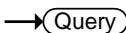

***OPC**

Description	The *OPC command sets the OPC bit (bit0) of the Standard Event Status Register when all current commands have been processed. The *OPC? Query returns 1 when all the outstanding commands have completed.		
Syntax	*OPC		
Query Syntax	*OPC?		
Return parameter	1	Returns 1 when all the outstanding commands have completed.	



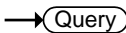

***SRE**

Description	Sets or queries the Service Request Enable register. The Service Request Enable register determines which registers of the Status Byte register are able to generate service requests.		
Syntax	*SRE <NR1>		
Query Syntax	*SRE?		
Parameter/ Return parameter	<NR1>	0~255	

Bit Weight	Bit#	Weight	Event	Description
	0	1		Not used
	1	2		Not used
	2	4		Not used
	3	8		Not used
	4	16	MAV	Message Available Bit
	5	32	ESB	Event Status Bit
	6	64	MSS	Master Summary Bit
	6	64	RQS	Request Service Bit

	7	128		Not used
--	---	-----	--	----------

Example *SRE?
 >48
 Indicates that the MAVB and ESB bit are both set.

***STB** → Query

Description Queries the bit sum of the Status Byte register with MSS (Master summary Status) replacing the RQS bit (bit 6).

Query Syntax *STB?

Return parameter <NR1> 0 ~ 255

Bit Weight	Bit#	Weight	Event	Description
	0	1		Not used
	1	2		Not used
	2	4		Not used
	3	8		Not used
	4	16	MAV	Message Available Bit
	5	32	ESB	Event Status Bit
	6	64	MSS	Master Summary Bit
	6	64	RQS	Request Service Bit
	7	128		Not used

Example *STB?
 >16
 Indicates that the MAV bit is set.

Acquisition Commands

:ACQuire:AVERage.....	35
:ACQuire:MODE	36
:ACQuire<X>:MEMory?	36
:ACQuire:FILTer:SOURce	38
:ACQuire:FILTer.....	39
:ACQuire:FILTer:FREQuency.....	39
:ACQuire:FILTer:TRACking.....	40
:ACQuire<X>:STATe?.....	40
:ACQuire:RECOrdlength.....	40
:HEADer.....	41

:ACQuire:AVERage



Description	Selects or returns the number of waveform acquisitions that are averaged in the average acquisition mode.
Syntax	:ACQuire:AVERage {<NR1> ?}
Related Commands	:ACQuire:MODE
Parameter	<NR1> 2, 4, 8, 16, 32, 64, 128, 256
Note	Before using this command, select the average acquisition mode. See the example below.
Example	:ACQuire:MODE AVERage :ACQuire:AVERage 2 Selects the average acquisition mode, and sets the average number to 2.

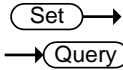

:ACQuire:MODE

Description	Selects or returns the acquisition mode.						
Syntax	:ACQuire:MODE {SAMPlE PDETECT AVERAge ?}						
Related Commands	:ACQuire:AVERAge						
Parameter	<table border="0"> <tr> <td>SAMPlE</td> <td>Sample mode sampling</td> </tr> <tr> <td>PDETECT</td> <td>Peak detect sampling</td> </tr> <tr> <td>AVERAge</td> <td>Average sampling mode</td> </tr> </table>	SAMPlE	Sample mode sampling	PDETECT	Peak detect sampling	AVERAge	Average sampling mode
SAMPlE	Sample mode sampling						
PDETECT	Peak detect sampling						
AVERAge	Average sampling mode						
Example	:ACQuire:MODE PDETECT Sets the sampling mode to peak detection.						

:ACQuire<X>:MEMory?



Description	Returns the data in acquisition memory for the selected channel as a header + raw data.				
Syntax	:ACQuire<X>:MEMory?				
Related Commands	:ACQuire:RECOrdlength :HEADer				
Parameter	<X> Channel number (1 to 4)				
Return parameter	<table border="0"> <tr> <td><string></td> <td>Returns acquisition settings followed by raw waveform block data.</td> </tr> <tr> <td><waveform block data></td> <td><string> Returns the acquisition settings for the selected channel. Format: parameter(1),setting(1);parameter(2),setting(2)...parameter(n),setting(n);Waveform Data; <waveform block data> Header followed by the raw waveform data.</td> </tr> </table>	<string>	Returns acquisition settings followed by raw waveform block data.	<waveform block data>	<string> Returns the acquisition settings for the selected channel. Format: parameter(1),setting(1);parameter(2),setting(2)...parameter(n),setting(n);Waveform Data; <waveform block data> Header followed by the raw waveform data.
<string>	Returns acquisition settings followed by raw waveform block data.				
<waveform block data>	<string> Returns the acquisition settings for the selected channel. Format: parameter(1),setting(1);parameter(2),setting(2)...parameter(n),setting(n);Waveform Data; <waveform block data> Header followed by the raw waveform data.				

Format:

Header: The header (in ASCII) encodes the number of bytes for the header followed by the number of data points in bytes for the raw data.

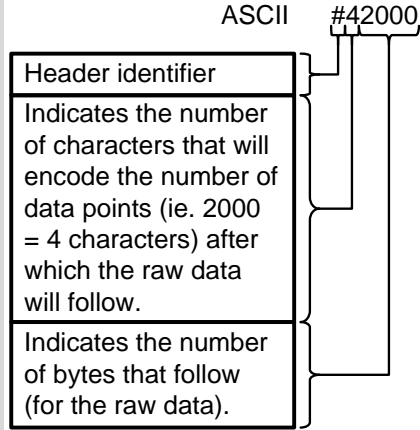

Raw Data:

Each two bytes (in hex) encodes the vertical data of a data point. The data is signed hex data (2's complement, -32768 ~ 32767).

Waveform Raw Data Example:

Header raw data.....

Hex:

23 34 32 30 30 30 00 1C 00 1B 00 1A 00
1A 00 1B

ASCII/Decimal:

#42000 28 27 26 26 27.....

The actual value of a data point can be calculated with the following formula:
(Decimal value of hex data/AD Factor) * vertical scale.

Note: AD Factor is fixed as 25. The vertical scale is returned with the

acquisition settings that precede the raw data.

For example if the raw data for a point is 001C (=28 decimal) then,
 $(28/25) \times 0.5 = 0.56V$

Example :ACQuire1:MEMory?
 Format,1.0B;Memory Length,10000;IntpDistance,0;
 Trigger Address,4999;Trigger Level,1.160E+01;
 Source,CH1;Vertical Units,V;Vertical Units
 Div,0;Vertical Units Extend
 Div,15;Label,ACK ;Probe Type,0;Probe
 Ratio,1.000e+01;Vertical Scale,5.000e+00;Vertical
 Position,-1.100e+01;Horizontal Units,S;Horizontal
 Scale,5.000E-04;Horizontal Position,0.000E+00;
 Horizontal Mode,Main;SincET Mode,Real
 Time;Sampling Period,5.000e-07;Horizontal Old
 Scale,5.000E-04;Horizontal Old Position,0.000E+00;
 Firmware,V0.99b8;Waveform Data;
 #520000.....follows waveform block
 data in hex.....

Set →

→ Query

:ACQuire:FILTer:SOURce

Description	Returns the source of the filter.
Note	This command is only applicable when the Digital Filter app is installed. See the Digital Filter app user manual for details.
Syntax	:ACQuire:FILTer:SOURce {CH1 CH2 CH3 CH4 ?}
Parameter/ Return parameter	CH1 ~ CH4 Source channel
Example	:ACQuire:FILTer:SOURce? CH1 Sets the filter source to CH1.

:ACQUIRE:FILTER



Description	Turns the filter on/off or queries its status.	
Note	This command is only applicable when the Digital Filter app is installed. See the Digital Filter app user manual for details.	
Syntax	:ACQUIRE:FILTER {ON OFF ?}	
Parameter/ Return parameter	ON	Filter on.
	OFF	Filter off.
Example	:ACQUIRE:FILTER? OFF Indicates that the filter is turned off.	

:ACQUIRE:FILTER:FREQUENCY



Description	Sets or queries the filter frequency.	
Note	This command is only applicable when the Digital Filter app is installed. See the Digital Filter app user manual for details.	
Syntax	:ACQUIRE:FILTER:FREQUENCY {DEFAULT <NRF> ?}	
Parameter/ Return parameter	DEFAULT	Sets the filter frequency to the default.
	<NRF>	Manually sets the filter frequency. (1Hz ~ 500MHz)
Example	:ACQUIRE:FILTER:FREQUENCY 1 Sets the filter frequency to 1Hz.	

:ACquire:FILTer:TRACking (Set) →
→ (Query)

Description	Turns filter tracking on/off or queries its state.	
Note	This command is only applicable when the Digital Filter app is installed. See the Digital Filter app user manual for details.	
Syntax	:ACquire:FILTer:TRACking {ON OFF ?}	
Parameter/ Return parameter	OFF	Tracking off
	ON	Tracking on
Example	:ACquire:FILTer:TRACking ON Turns filter tracking on.	

:ACquire<X>:STATe? → (Query)

Description	Returns the status of waveform data.	
Syntax	:ACquire<X>:STATe?	
Parameter	<X>	Channel number (1 to 4)
Return parameter	0	Raw data is not ready
	1	Raw data is ready
Example	:ACquire1:STATe? 0 Returns 0. Channel 1's raw data is not ready. <i>Note: If the oscilloscope changes the acquisition status from STOP to RUN, the status will be reset as zero.</i>	

:ACquire:RECOrdlength (Set) →
→ (Query)

Description	Sets or queries the record length.	
Syntax	:ACquire:RECOrdlength {<NRf> ?}	
Parameter/Return parameter	<NRf>	Record length. Settable record length: (1e+3 1e+4 1e+5 1e+6 1e+7)

Example :ACQuire:RECOrdlength 1e+3
 Sets the record length to 1000 points.

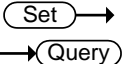
:HEADer 

Description Configures whether the returned data of the :ACQuire:MEM query will contain header information or not. It is set to ON by default.

Syntax :HEADer {OFF | ON | ?}

Related Commands :ACQuire<X>:MEMory?

Parameter	ON	Add header information.
	OFF	Don't add header information.

Return parameter Returns the configuration (ON, OFF) for the selected channel.

Example :HEADer ON

Autoscale Commands

:AUTOSet.....	42
:AUTORSET:MODE.....	42

:AUTOSet



Description Runs the Autoset function to automatically configure the horizontal scale, vertical scale, and trigger according to the input signal.

Syntax :AUTOSet

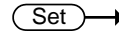

:AUTORSET:MODE

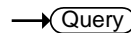

Description Sets the Autoset mode or queries its state.

Syntax :AUTORSET:MODE {FITScreen | ACPriority | ?}

Related Commands :AUTOSet

Parameter/Return parameter	FITScreen	Fit Screen mode
	ACPriority	AC priority mode

Example :AUTORSET?
FITSCREEN

Vertical Commands

:CHANnel<X>:BWLimit.....	43
:CHANnel<X>:COUPling.....	44
:CHANnel<X>:DESKew	44
:CHANnel<X>:DISPlay	44
:CHANnel<X>:EXPanD	45
:CHANnel<X>:IMPedance?.....	45
:CHANnel<X>:INVert	46
:CHANnel<X>:POSition	46
:CHANnel<X>:PROBe:RATio	47
:CHANnel<X>:PROBe:TYPe.....	47
:CHANnel<X>:SCALE	47

:CHANnel<X>:BWLimit



Description	Sets or returns the bandwidth limit on/off.	
Syntax	:CHANnel<X>:BWLimit {FULL <NR3> ?}	
Parameter	<X>	Channel 1,2,3,4
	FULL	Full bandwidth
	<NR3>	Sets the bandwidth limit to a pre-defined bandwidth. 20E+6: 20MHz
Return Parameter	<NR3>	Returns the bandwidth.
	Full	Full bandwidth
Example	:CHANnel1:BWLimit 2.000E+07 Sets the channel 1 bandwidth to 20MHz.	

:CHANnel<X>:COUPling
 →
 →

Description	Selects or returns the coupling mode.	
Syntax	CHANnel<X>:COUPling {AC DC GND ?}	
Parameter	<X>	Channel 1,2,3,4
	AC	AC coupling
	DC	DC coupling
	GND	Ground coupling
Return parameter	Returns the coupling mode.	
Example	:CHANnel1:COUPling DC Sets the coupling to DC for Channel 1.	

:CHANnel<X>:DESKew
 →
 →

Description	Sets the deskew time in seconds.	
Syntax	:CHANnel<X>:DESKew { <NR3> ?}	
Parameter	<X>	Channel 1,2,3,4
	<NR3>	Deskew time: -5.00E -11 to 5.00E-11 -50ns to 50 ns. (10 ps /step)
Return parameter	<NR3>	Returns the deskew time.
Example	:CHANnel1:DESKew 1.300E-9 Sets the deskew time to 1.3 nano seconds.	

:CHANnel<X>:DISPlay
 →
 →

Description	Turns a channel on/off or returns its status.	
Syntax	:CHANnel<X>:DISPlay {OFF ON ?}	
Parameter	<X>	Channel 1,2,3,4
	OFF	Channel off
	ON	Channel on

Return Parameter	ON	Channel is on
	OFF	Channel is off

Example :CHANnel1:DISPlay ON
Turns on Channel 1

:CHANnel<X>:EXPand

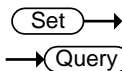

Description Sets Expand By Ground or Expand By Center for a channel or queries its status.

Syntax :CHANnel<X>:EXPand {GND | CENTER | ?}

Parameter	<X>	Channel 1,2,3,4
	GND	Ground
	CENTER	Center

Return parameter	GND	Expand By Ground
	CENTER	Expand By Center

Example :CHANnel1:EXPand GND
Sets Channel 1 to Expand By Ground.

:CHANnel<X>:IMPedance?



Description Returns the impedance of the oscilloscope. (The impedance of the GDS-1000B is fixed at 1MΩ)

Syntax :CHANnel<X>:IMPedance?

Parameter	<x>	Channel
	1/2/3/4	CH1/2/3/4

Return parameter <NR3> Returns the impedance value.

Example :CHANnel1:IMPedance?
1.000000E+06
The impedance is 1M ohms.

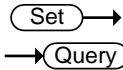

:CHANnel<X>:INVert

Description	Inverts a channel or returns its status.	
Syntax	:CHANnel<X>:INVert {OFF ON ?}	
Parameter	<X>	Channel 1, 2, 3, 4
	OFF	Invert off
	ON	Invert on
Return parameter	ON	Invert on
	OFF	Invert off
Example	:CHANnel1:INVert ON Inverts Channel 1	

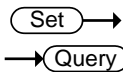

:CHANnel<X>:POSition

Description	Sets or returns the position level for a channel.	
Note	The vertical position will only be set to closest allowed value. The position level range depends on the vertical scale. The scale must first be set before the position can be set.	
Syntax	:CHANnel<X>:POSition { <NRf> ?}	
Parameter	<X>	Channel 1, 2, 3, 4
	<NRf>	Position. Range depends on the vertical scale.
Return parameter	<NR3>	Returns the position value.
Example 1	:CHANnel1:POSition 2.4E-3 Sets the Channel 1 position to 2.4mV/mA	
Example 2	:CHANnel1:POSition? 2.4E-3 Returns 2.4mV as the vertical position.	

:CHANnel<X>:PROBE:RATio



Description	Sets or returns the probe attenuation factor.	
Syntax	:CHANnel<X>:PROBE:RATio { <NRf> ? }	
Related Commands	:CHANnel<X>:PROBE:TYPE	
Parameter	<X>	Channel 1, 2, 3, 4
	<NRf>	Probe attenuation factor
Return parameter	<NR3>	Returns the probe attenuation factor
Example	:CHANnel1:PROBE:RATio 1.00E+0 Sets the Channel 1 probe attenuation factor to 1x	

:CHANnel<X>:PROBE:TYPE



Description	Sets or returns the probe type (voltage/current).	
Syntax	:CHANnel<X>:PROBE:TYPE { VOLTage CURRent ? }	
Related Commands	:CHANnel<X>:PROBE:RATio	
Parameter	<X>	Channel 1, 2, 3, 4
	VOLTage	Voltage
	CURRent	Current
Return parameter	Returns the probe type.	
Example	:CHANnel1:PROBE:TYPE VOLTage Sets the Channel 1 probe type to voltage.	

:CHANnel<X>:SCALE





Description	<p>Sets or returns the vertical scale. The scale depends on the probe attenuation factor.</p> <p>Note the probe attenuation factor should be set before the scale.</p>
-------------	--

Syntax	:CHANnel<X>:SCALE { <NRf> ?}	
Parameter	<X>	Channel 1, 2, 3, 4
	<NRf>	Vertical scale: 2e-3 to 1e+1 2mV to 10V (Probe x1)
Return parameter	<NR3>	Returns the vertical scale in volts or amps.
Example	:CHANnel1:SCALE 2.00E-2	
	Sets the Channel 1 vertical scale to 20mV/div	

Math Commands

:MATH:DISP	49
:MATH:TYPE	50
:MATH:DUAL:SOURce<X>	50
:MATH:DUAL:OPERator	50
:MATH:DUAL:POSition.....	51
:MATH:DUAL:SCALe	51
:MATH:FFT:SOURce	52
:MATH:FFT:MAG.....	52
:MATH:FFT:WINDow	52
:MATH:FFT:POSition	53
:MATH:FFT:SCALe.....	53
:MATH:FFT:HORIZontal:SCALe.....	54
MATH:FFT:HORIZontal:POSition.....	54
:MATH:DEFine	54
MATHVAR?	55
MATHVAR:VAR<X>.....	56
:MATH:ADVanced:POSition	56
:MATH:ADVanced:SCALe.....	56

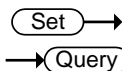
:MATH:DISP



Description	Turns the math display on or off on the screen.	
Syntax	:MATH:DISP {OFF ON ?}	
Parameter/ Return parameter	OFF	Math is not displayed on screen
	ON	Math is displayed on screen
Example	:MATH:DISP OFF Math is off.	

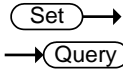

:MATH:TYPE

Description	Queries or sets the Math type to FFT, Advanced Math or to dual channel math operations (basic +, -, \times , \div , operations).						
Syntax	:MATH:TYPE { DUAL ADVanced FFT ? }						
Related Commands	:MATH:DISP						
Parameter	<table border="1"> <tr> <td>DUAL</td> <td>Dual channel operations</td> </tr> <tr> <td>ADVanced</td> <td>Advanced math operations</td> </tr> <tr> <td>FFT</td> <td>FFT operations</td> </tr> </table>	DUAL	Dual channel operations	ADVanced	Advanced math operations	FFT	FFT operations
DUAL	Dual channel operations						
ADVanced	Advanced math operations						
FFT	FFT operations						
Return parameter	Returns the math type.						
Example	:MATH:TYPE DUAL Sets the Math type to dual channel math operation.						

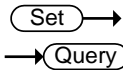

:MATH:DUAL:SOURce<X>

Description	Sets the dual math source for source 1 or 2.						
Syntax	:MATH:DUAL:SOURce<X> { CH1 CH2 CH3 CH4 REF1 REF2 REF3 REF4 ? }						
Parameter	<table border="1"> <tr> <td><X></td> <td>Source number 1 or 2</td> </tr> <tr> <td>CH1~4</td> <td>Channel 1 to 4</td> </tr> <tr> <td>REF1~4</td> <td>Reference waveforms 1 to 4</td> </tr> </table>	<X>	Source number 1 or 2	CH1~4	Channel 1 to 4	REF1~4	Reference waveforms 1 to 4
<X>	Source number 1 or 2						
CH1~4	Channel 1 to 4						
REF1~4	Reference waveforms 1 to 4						
Return parameter	Returns the source for the source 1 or 2.						
Example	:MATH:DUAL:SOURce1 CH1 Sets source1 as channel 1.						

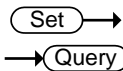

:MATH:DUAL:OPERator

Description	Sets the math operator for dual math operations.
-------------	--

Syntax	:MATH:DUAL:OPERator {PLUS MINUS MUL DIV ?}	
Parameter	PLUS	+ operator
	MINUS	- operator
	MUL	× operator
	DIV	÷ operator
Return parameter	Returns operator type.	
Example	:MATH:DUAL:OPERator PLUS Sets the math operator as plus (+).	

:MATH:DUAL:POSition



Description	Sets the vertical position of the displayed math result expressed by unit/division.	
Syntax	:MATH:DUAL:POSition {<NRf> ? }	
Parameter	<NRf>	Vertical position Depends on the vertical scale (Unit/Div)
Return parameter	<NR3>	Returns the vertical position.
Example	:MATH:DUAL:POSition 1.0E+0 Sets the vertical position to 1.00 unit/div.	

:MATH:DUAL:SCALE



Description	Sets the vertical scale of the displayed math result.	
Syntax	:MATH:DUAL:SCALE {<NRf> ?}	
Parameter	<NRf>	Vertical scale
Return parameter	<NR3>	Returns the scale.
Example	:MATH:DUAL:SCALE 2.0E-3 Sets the vertical scale to 2mV/2mA.	

Set →
→ Query

:MATH:FFT:SOURce

Description	Sets and queries the FFT math source.	
Syntax	:MATH:FFT:SOURce { CH1 CH2 CH3 CH4 REF1 REF2 REF3 REF4 ? }	
Related commands	:MATH:ADVanced:EDIT:SOURce<X> :MATH:ADVanced:EDIT:OPERator	
Parameter	CH1~4	Channel 1 to 4
	REF1~4	Reference waveform 1 to 4
Return parameter	Returns the FFT source.	
Example	:MATH:FFT:SOURce CH1 Sets the FFT math source as channel 1.	

Set →
→ Query

:MATH:FFT:MAG

Description	Sets FFT vertical units as linear or decibels.	
Syntax	:MATH:FFT:MAG {LINEAR DB ?}	
Parameter	LINEAR	Linear units (Vrms)
	DB	Logarithmic units (dB)
Return parameter	Returns the FFT vertical units.	
Example	:MATH:FFT:MAG DB Sets FFT vertical units to dB.	

Set →
→ Query

:MATH:FFT:WINDow

Description	Sets the windowing filter used for the FFT function.	
Syntax	:MATH:FFT:WINDow {RECTangular HAMming HANning BLAckman ?}	

Parameter	RECTangular	Rectangular window
	HAMming	Hamming window
	HANning	Hanning window
	BLAckman	Blackman window

Return parameter Returns the FFT window.

Example :MATH:FFT:WINDow HAMming
Sets the FFT window filter to hamming.

Set →

→ Query

:MATH:FFT:POSition

Description Sets the vertical position of the displayed FFT result.

Syntax MATH:FFT:POSition { <NRf> | ? }

Parameter	<NRf>	Vertical position: -12e+0 to +12e+0 (12 units/division to +12 units/division.)
-----------	-------	---

Return parameter	<NR3>	Returns the vertical position.
------------------	-------	--------------------------------

Example :MATH:FFT:POSition -2e-1
Sets the FFT position to -0.2 divisions.

Set →

→ Query

:MATH:FFT:SCALe

Description Sets the vertical scale of the displayed FFT result.

Syntax :MATH:FFT:SCALe {<NRf> | ?}

Parameter	<NRf>	Vertical scale: Linear: 2e-3 to 1e+3 (2mV~1kV) dB: 1e+0 to 2e+1 (1~20dB)
-----------	-------	--

Return parameter	<NR3>	Returns vertical scale.
------------------	-------	-------------------------

Example :MATH:FFT:SCALe 1.0e+0
Sets the scale to 1dB.

:MATH:FFT:HORizontal:SCALE (Set) →
→ (Query)

Description	Sets or queries the zoom scale for FFT math.	
Syntax	:MATH:FFT:HORizontal:SCALE {<NRf> ?}	
Parameter	<NRf>	Zoom scale: 1 to 20 times
Return parameter	<NR3>	Returns zoom scale.
Example	:MATH:FFT:HORizontal:SCALE 5 Sets the zoom scale to 5X.	

MATH:FFT:HORizontal:POSition (Set) →
→ (Query)

Description	Sets the horizontal position of the displayed FFT result.	
Syntax	MATH:FFT:HORizontal:POSition { <NRf> ? }	
Parameter	<NRf>	Horizontal position: 0Hz ~ 999.9kHz
Return parameter	<NR3>	Returns the vertical position.
Example	:MATH:FFT:HORizontal:POSition 6.0e5 Sets the FFT horizontal position to 600kHz.	

:MATH:DEFine (Set) →
→ (Query)

Description	Sets or queries the advanced math expression as a string.	
Syntax	:MATH:DEFine {<string> ?}	
Related	:MATH:DISP :MATH:TYPE	
Parameter	<string>	An expression enclosed in double quotes. Note, ensure parentheses are used correctly in the expression. The expression can contain the following parts:

Source	CH1~CH4, Ref1~Ref4
Function	Intg(, Diff(, log(, ln(, Exp(, Sqrt(, Abs(, Rad(, Deg(, sin(, cos(, tan(, asin(, acos(, atan(
Variable	VAR1, VAR2
Operator	+, -, *, /, (,), !(, <, >, <=, >=, ==, !=, , &&
Figure	0, 1, 2, 3, 4, 5, 6, 7, 8, 9, ., E
Measurement	Pk-Pk(, Max(, Min(, Amp(, High(, Low(, Mean(, CycleMean(, RMS(, CycleRMS(, Area(, CycleArea(, ROVShoot(, FOVShoot(, Freq(, Period(, Rise(, Fall(, PosWidth(, NegWidth(, Dutycycle(, FRR(, FRF(, FFR(, FFF(, LRR(, LRF(, LFR(, LFF(, Phase(

Return parameter Returns the expression as a string.

Example :MATH:DISP ON
:MATH:TYPE ADVanced
MATH:DEFine "CH1-CH2"
Sets the math expression to CH1-CH2.

MATHVAR?



Description	Returns the value of the VAR1 and VAR2 variables.
Syntax	MATHVAR?
Related Commands	MATHVAR:VAR<X> MATH:DEFine
Return parameter	<string> VAR1 <NR3>; VAR2 <NR3>

Example MATHVAR?
 VAR1 1.000000E+06; VAR2 1.0E+1
 Returns the value of both variables.

Set →

MATHVAR:VAR<X>

→ Query

Description	Sets or returns the VAR1 or VAR2 variables.	
Syntax	MATHVAR:VAR<x> {<NRf> ?}	
Related Commands	MATH:DEFine	
Parameter	<X>	1, 2 (VAR1 or VAR2)
	<NRf>	Value of VAR1/VAR2
Return parameter	<NR3>	Returns the value of VAR1/VAR2
Example	:MATH:VAR1 6.0e4 Sets VAR1 to 60000.	

Set →

:MATH:ADVanced:POSition

→ Query

Description	Sets the vertical position of the advanced math result, expressed in unit/div.	
Syntax	MATH:ADVanced:POSition {<NRf> ?}	
Parameter	<NRf>	Vertical position: -12e+0 to +12e+0 (12 units/division to +12 units/division.)
Return parameter	<NR3>	Returns the vertical position.
Example	:MATH:ADVanced:POSition 1.0e+0 Sets the position as 1.00 unit/div.	

Set →

:MATH:ADVanced:SCALE

→ Query

Description	Sets or queries the vertical scale the advanced math result.	
Syntax	:MATH:ADVanced:SCALE {<NRf> ?}	

Parameter	<NRf>	Vertical scale
Return parameter	<NR3>	Returns the vertical scale.
Example	:MATH:ADVanced:SCALE 2.0E-3 Sets the vertical scale to 2mV/Div.	

Cursor Commands

:CURSor:MODE	58
:CURSor:SOURce	59
:CURSor:HUNI	59
:CURSor:HUSE	60
:CURSor:VUNI	60
:CURSor:VUSE	61
:CURSor:DDT	61
:CURSor:H1Position	61
:CURSor:H2Position	62
:CURSor:HDELta	62
:CURSor:V1Position	62
:CURSor:V2Position	63
:CURSor:VDELta	63
:CURSor:XY:RECTangular:X:POSition<X>	63
:CURSor:XY:RECTangular:X:DELta	64
:CURSor:XY:RECTangular:Y:POSition<X>	64
:CURSor:XY:RECTangular:Y:DELta	65
:CURSor:XY:POLar:RADIUS:POSition<X>	65
:CURSor:XY:POLar:RADIUS:DELta	65
:CURSor:XY:POLar:THETA:POSition<X>	66
:CURSor:XY:POLar:THETA:DELta	66
:CURSor:XY:PRODuct:POSition<X>	66
:CURSor:XY:PRODuct:DELta	67
:CURSor:XY:RATio:POSition<X>	67
:CURSor:XY:RATio:DELta	67

:CURSor:MODE

Description Sets cursor mode to horizontal (H) or horizontal and vertical (HV).

Syntax :CURSor:MODE {OFF | H | HV | ? }

Parameter	OFF	Turns the cursors off.
	H	Turns the horizontal cursors on.
	HV	Turns horizontal and vertical cursors on.

Return parameter Returns the state of the cursors (H, HV, OFF).

Example :CURSor:MODE OFF
Turns the cursors off.

:CURSor:SOURce

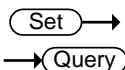

Description	Sets or queries the cursor source.	
Syntax	:CURSor:SOURce {CH1 CH2 CH3 CH4 REF1 REF2 REF3 REF4 MATH ?}	
Parameter	CH1~CH4	Channel 1 to 4
	REF1~4	Reference waveform 1 to 4
	MATH	Math source

Return parameter Returns the cursor source.

Example :CURSor:SOURce CH1
Turns the cursor source as channel 1.

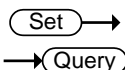

:CURSor:HUNI

Description	Sets or queries the units for the horizontal bar cursors.	
Syntax	:CURSor:HUNI {SECOnds HERTz DEGRees PERcent ?}	
Related Commands	:CURSor:MODE	
Parameter	SECOnds	Sets the cursor units to time in seconds.
	HERTz	Sets the cursor units to frequency.
	DEGRees	Sets the cursor units to degrees.
	PERcent	Sets the cursor units to percent.

Return parameter Returns the unit type.

Example :CURSor:HUNI SEConds
Sets the units to time in seconds.

:CURSor:HUSE



Description Sets the current cursor position as the phase or ratio reference for the Percent or Degrees (horizontal) cursors.

Note This command can only be used when :CURSor:HUNI is set to DEGRees or PERcent.

Syntax :CURSor:HUSE {CURRent}

Related Commands :CURSor:MODE
:CURSor:HUNI

Parameter CURRent Uses the current horizontal position

Example :CURSor:HUSE CURRent.

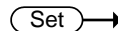

:CURSor:VUNI



Description Sets or queries the units for the vertical bar cursors.

Syntax :CURSor:VUNI {BASE | PERcent | ?}

Related Commands :CURSor:MODE
Commands

Parameter BASE Sets the vertical cursor units the same as the scope units (V or A).
PERcent Sets the displayed units to percent.

Return parameter Returns the unit type.

Example :CURSor:VUNI BASE
Sets the units to the base units.

:CURSor:VUSE

Set →

Description	Sets the current cursor position as the ratio reference for the Percent (vertical) cursors.
Note	This command can only be used when :CURSor:VUNI is set to PERcent.
Syntax	:CURSor:VUSE {CURRent}
Related Commands	:CURSor:MODE :CURSor:VUNI
Parameter	CURRent Uses the current vertical position
Example	:CURSor:VUSE CURRent.

:CURSor:DDT

→ Query

Description	Returns the deltaY/deltaT (dy/dT) readout. This function is only supported if the source channels are CH1~4, Ref1~4 or Math.
Syntax	:CURSor:DDT{?}
Related Commands	:CURSor:MODE
Return Parameter	<NR3> Returns the readout in <NR3> format.
Example	:CURSor:DDT? 4.00E-05

Set →

:CURSor:H1Position

→ Query

Description	Sets or returns the first horizontal cursor (H1) position.
Syntax	:CURSor:H1Position {<NRF> ?}
Related Commands	:CURSor:H2Position

Parameter	<NRf>	Horizontal position
Return parameter	Returns the cursor position.	
Example	:CURSOR:H1Position? -1.34E-3 Returns the H1 cursor position as -1.34ms.	

Set →

→ Query

:CURSOR:H2Position

Description	Sets or returns the second horizontal cursor (H2) position.	
Syntax	:CURSOR:H2Position {<NRf> ?}	
Related Commands	:CURSOR:H1Position	

Parameter	<NRf>	Horizontal position
Return parameter	Returns the cursor position.	
Example	:CURSOR:H2Position 1.5E-3 Sets the H2 cursor position to 1.5ms.	

→ Query

:CURSOR:HDELta

Description	Returns the delta of H1 and H2.	
Syntax	:CURSOR:HDELta{?}	
Return Parameter	<NR3>	Returns the distance between two horizontal cursors.

Example	:CURSOR:HDELta? 5.0E-9 Returns the horizontal delta as 5ns.	
---------	---	--

Set →

→ Query

:CURSOR:V1Position

Description	Sets the first vertical cursor (V1) position.	
-------------	---	--

Syntax	:CURSor:V1Position {<NRf> ?}	
Parameter	<NRf>	Vertical position. Depends on the vertical scale.
Return parameter	<NR3>	Returns the cursor position.
Example	:CURSor:V1Position 1.6E -1 Sets the V1 cursor position to 160mA.	

Set →

→ Query

:CURSor:V2Position

Description	Sets the first vertical cursor (V2) position.	
Syntax	:CURSor:V2Position {<NRf> ?}	
Parameter	<NRf>	Vertical position. Depends on the vertical scale.
Return parameter	<NR3>	Returns the cursor position.
Example	:CURSor:V2Position 1.1E-1 Sets the V2 cursor position to 110mA.	

:CURSor:VDELta

→ Query

Description	Returns the delta of V1 and V2.	
Syntax	:CURSor:VDELta{?}	
Return Parameter	<NR3>	Returns the difference between two vertical cursors.
Example	:CURSor:VDELta? 4.00E+0 Returns the vertical delta as 4 volts.	

Set →

→ Query

:CURSor:XY:RECTangular:X:POSition<X>

Description	Sets or queries the horizontal position in XY mode for the X rectangular coordinates for cursor 1 or 2.	
Syntax	:CURSor:XY:RECTangular:X:POSition<X> {<NRf> ?}	

Parameter	<X>	Cursor 1, 2
	<NRf>	Horizontal position co-ordinates
Return parameter	<NR3>	Returns the cursor position.
Example	:CURSor:XY:RECTangular:X:POSition1 4.0E-3 Sets the X-coordinate cursor 1 position to 40mV/mV.	

:CURSor:XY:RECTangular:X:DELta → Query

Description	Returns the delta value of cursor 1 and 2 on the X coordinate.	
Syntax	:CURSor:XY:RECTangular:X:DELta{?}	
Return Parameter	<NR3>	Returns the delta value of cursor 1 and 2 as <NR3>.
Example	:CURSor:XY:RECTangular:X:DELta? 80.0E-3 Returns the horizontal delta as 80mV.	

Set →

:CURSor:XY:RECTangular:Y:POSition<X> → Query

Description	Sets or queries the vertical position in XY mode for the Y rectangular coordinates for cursor 1 or 2.	
Syntax	:CURSor:XY:RECTangular:Y:POSition<X> {<NRf> ?}	
Parameter	<X>	Cursor 1, 2
	<NRf>	Vertical position co-ordinates
Return parameter	<NR3>	Returns the cursor position.
Example	:CURSor:XY:RECTangular:Y:POSition1 4.0E-3 Sets the Y-coordinate cursor 1 position to 40mV/mV.	

:CURSor:XY:RECTangular:Y:DELta → Query

Description	Returns the delta value of cursor 1 and 2 on the Y coordinate.
Syntax	:CURSor:XY:RECTangular:Y:DELta{?}
Return Parameter	<NR3> Returns the delta value of cursor 1 and 2 as <NR3>.
Example	:CURSor:XY:RECTangular:Y:DELta? 80.0E-3 Returns the horizontal delta as 80mV.

:CURSor:XY:POLar:RADIUS:POSition<X> → Query

Description	Queries the polar radius position for the specified cursor in XY mode, where X can be either cursor 1 or 2.
Syntax	:CURSor:XY:POLar:RADIUS:POSition<X>{?}
Parameter	<X> 1, 2 (cursor 1, cursor 2)
Return Parameter	<NR3> Returns the polar radius position.
Example	:CURSor:XY:POLar:RADIUS:POSition1? 80.0E-3 Returns the polar radius position as 80.0mV.

:CURSor:XY:POLar:RADIUS:DELta → Query

Description	Returns the radius delta value of cursor 1 and 2.
Syntax	:CURSor:XY:POLar:RADIUS:DELta{?}
Return Parameter	<NR3> Returns the radius delta.
Example	:CURSor:XY:POLar:RADIUS:DELta? 31.4E-3 Returns the radius delta as 31.4mV.

:CURSor:XY:POLar:THETA:POSition<X> → **Query**

Description	Queries the polar angle for the specified cursor in XY mode, where X can be either 1 or 2.	
Syntax	:CURSor:XY:POLar:THETA:POSition<X>{?}	
Parameter	<X>	1, 2 (Cursor 1, Cursor 2)
Return parameter	<NR3>	Returns the polar angle.
Example	:CURSor:XY:POLAR:RADIUS:POSition1? 8.91E+1 Returns the polar angle for cursor1 as 89.1°.	

:CURSor:XY:POLar:THETA:DELta → **Query**

Description	Queries the polar angle delta between cursor1 and cursor2.	
Syntax	:CURSor:XY:POLar:THETA:DELta{?}	
Return parameter	<NR3>	Returns the theta delta between cursor1 and cursor2.
Example	:CURSor:XY:POLar:THETA:DELta? 9.10E+0 Returns the delta as 9.1°.	

:CURSor:XY:PRODuct:POSition<X> → **Query**

Description	Queries the product in XY mode for the specified cursor, where x can be either 1 or 2.	
Syntax	:CURSor:XY:PRODuct:POSition<X>{?}	
Parameter	<X>	1, 2 (Cursor 1, Cursor 2)
Return parameter	<NR3>	Returns the product value of the Cursor1 or Cursor2.

Example :CURSor:XY:PRODUct:POSItion1?
9.44E-5
Returns the product of cursor1 as 94.4uVV.

:CURSor:XY:PRODUct:DELta 

Description Queries the product delta in XY mode.

Syntax :CURSor:XY:PRODUct:DELta{?}

Return parameter <NR3> Returns the product delta.

Example :CURSor:XY:PRODUct:DELta?
1.22E-5
Returns the product delta as 12.2uVV.

:CURSor:XY:RATio:POSItion<X> 

Description Queries the ratio in XY mode for the specified cursor, where x can be either cursor 1 or 2.

Syntax :CURSor:XY:RATio:POSItion<X>{?}

Parameter <X> 1, 2 (Cursor 1, Cursor 2)

Return parameter <NR3> Returns the ratio.

Example :CURSor:XY:RATio:POSItion?
6.717E+1
Returns the ratio value as 6.717V/V.

:CURSor:XY:RATio:DELta 

Description Queries the ratio delta in XY mode.

Syntax :CURSor:XY:RATio:DELta{?}

Return parameter <NR3> Returns the ratio delta.

Example :CURSor:XY:RATio:DELta?
 5.39E+1
 Returns the ratio delta as 53.9V/V.

Display Commands

:DISPlay:INTensity:WAVEform.....	69
:DISPlay:INTensity:GRATicule.....	69
:DISPlay:INTensity:BACKLight	70
:DISPlay:INTensity:BACKLight:AUTODim:ENABle ...	70
DISplay:INTENSITy:BACKLight:AUTODim:TIME	70
:DISPlay:PERsistence	71
:DISPlay:GRATicule	71
:DISPlay:WAVEform.....	72
:DISPlay:OUTPut	72

:DISPlay:INTensity:WAVEform (Set) →
→ (Query)

Description Sets or queries the waveform intensity level.

Syntax :DISPlay:INTensity:WAVEform {<NRf> | ?}

Parameter <NRf> 0.0E+0 to 1.0E+2 (0% to 100%)

Return Parameter <NR3> Returns the intensity.

Example :DISPlay:INTensity:WAVEform 5.0E+1
Sets the waveform intensity to 50%.

:DISPlay:INTensity:GRATicule (Set) →
→ (Query)

Description Sets or queries the graticule intensity level.

Syntax :DISPlay:INTensity:GRATicule {<NRf> | ?}

Parameter <NRf> 1.0E+0 to 1.0E+2 (10% to 100%)

Return Parameter <NR3> Returns the graticule intensity.

Example :DISPlay:INTensity:GRATicule 5.0E+1
Sets the graticule intensity to 50%.

:DISPlay:INTensity:BACKLight (Set) →
→ (Query)

Description	Sets or queries the intensity of the backlight display.	
Syntax	:DISPlay:INTensity:BACKLight {<NRf> ?}	
Parameter	<NRf>	1.0E+0 to 1.0E+2 (10% to 100%)
Return Parameter	<NR3>	Returns the backlight intensity.
Example	:DISPlay:INTensity:BACKLight 5.0E+1 Sets the backlight intensity to 50%.	

:DISPlay:INTensity:BACKLight:AUTODim:ENABLE (Set) →
→ (Query)

Description	Sets or queries the display auto-dim function.	
Syntax	:DISPlay:INTensity:BACKLight:AUTODim:ENABLE {OFF ON ?}	
Parameter/ Return parameter	OFF ON	Turn auto-dim on. Turn auto-dim off.
Example	:DISPlay:INTensity:BACKLight:AUTODim:ENABLE ON Turns the auto-dim function on.	

DISPlay:INTENSITY:BACKLight:AUTODim:TIME (Set) →
→ (Query)

Description	Sets or queries the display auto-dim time.	
Syntax	:DISPlay:INTensity:BACKLight:AUTODim:TIME {<NR1> ?}	
Parameter/ Return parameter	<NR1>	1 ~ 180 minutes. Time in minutes.
Example	:DISPlay:INTensity:BACKLight:AUTODim:TIME 10 Sets the auto-dim time to 10 minutes.	





Set →
 → Query

:DISPlay:PERsistence

Description	Sets or queries the waveform persistence level.		
Syntax	:DISPlay:PERsistence { INFIinite OFF <NRf> ? }		
Parameter	<NRf>	1.6E-2 ~ 4.0E+0. (16mS to 4S) Range(1.6E-2, 30E-3, 60E-3, 120E-2, 240E-3, 500E-3, 750E-3, 1, 1.5,2, 4	
	INFIinite	Infinite persistence	
	OFF	No persistence	
Return Parameter	<NR3>	Returns the persistence time.	
	INFIinite	Infinite persistence	
	OFF	No persistence	
Example	:DISPlay:PERsistence 2.0E+0 Sets the persistence to 2 seconds.		

Set →
 → Query

:DISPlay:GRATicule

Description	Sets or queries graticule display type.			
Syntax	:DISPlay:GRATicule {FULL GRID CROsSs FRAMe ?}			
Parameter	FULL		CROsSs	
	FRAMe		GRID	
Return parameter	Returns the graticule type.			
Example	:DISPlay:GRATicule FULL Sets the graticule to  .			

Set →
 → Query

:DISPlay:WAVEform

Description	Sets or queries whether the waveforms are drawn as vectors or dots.	
Syntax	:DISPlay:WAVEform {VECTor DOT ?}	
Parameter	VECTor	Vectors
	DOT	Dots
Return parameter	Returns VECTOR or DOT.	
Example	:DISPlay:WAVEform VECTor Sets the waveform to vectors.	

→ Query

:DISPlay:OUTPut

Description	Returns the screen image as a 16 bit RGB run length encoded image.
Syntax	:DISPlay:OUTPut{?}
Return parameter	Format: header+data+LF For example assuming the image data size is 60072 bytes then the following would be returned: #560072<[count] [color] [count] [color]..... ><LF> Where #560072 is the header, each [count] and [color] data are 2 bytes and <LF> is a line feed character.

Hardcopy Commands

:HARDcopy:START	73
:HARDcopy:MODE	73
:HARDcopy:PRINTINKSaver	74
:HARDcopy:SAVEINKSaver	74
:HARDcopy:SAVEFORMat	74
:HARDcopy:ASSIGN	75

:HARDcopy:START

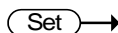

Description	Executing the HARDcopy:START command is the equivalent of pressing the Hardcopy key on the front panel.
Syntax	:HARDcopy:START
Related Commands	:HARDcopy:MODE :HARDcopy:PRINTINKSaver :HARDcopy:SAVEINKSaver :HARDcopy:SAVEFORMat :HARDcopy:ASSIGN

:HARDcopy:MODE

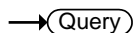
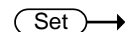

Description	Sets or queries whether hardcopy is set to print or save.				
Syntax	:HARDcopy:MODE { PRINT SAVE ? }				
Related Commands	:HARDcopy:START				
Parameter	<table> <tr> <td>PRINT</td> <td>Print mode</td> </tr> <tr> <td>SAVE</td> <td>Save mode</td> </tr> </table>	PRINT	Print mode	SAVE	Save mode
PRINT	Print mode				
SAVE	Save mode				
Return parameter	Returns the mode.(PRINT/SAVE)				

Example :HARDcopy:MODE PRINT
Sets hardcopy to print.

:HARDcopy:PRINTINKSaver (Set) →
→ (Query)

Description	Sets Inksaver On or Off for printing.	
Syntax	:HARDcopy:PRINTINKSaver { OFF ON ? }	
Related Commands	:HARDcopy:START :HARDcopy:MODE	
Parameter	ON	Inksaver ON
	OFF	Inksaver OFF
Return parameter	Returns the print Ink Saver mode.(ON/OFF)	

Example :HARDcopy:PRINTINKSaver ON
Sets Ink Saver to ON for printing.

:HARDcopy:SAVEINKSaver (Set) →
→ (Query)

Description	Sets Inksaver On or Off for saving screen images.	
Syntax	:HARDcopy:SAVEINKSaver { OFF ON ? }	
Related Commands	:HARDcopy:START :HARDcopy:MODE	
Parameter	ON	Inksaver ON
	OFF	Inksaver OFF
Return parameter	Returns the screen image Ink Saver mode (ON/OFF).	

Example :HARDcopy:SAVEINKSaver ON
Sets Inksaver to ON for saving screen images.

:HARDcopy:SAVEFORMat (Set) →
→ (Query)

Description	Sets or queries the image save file type.	
Syntax	:HARDcopy:SAVEFORMat { PNG BMP ? }	

Related Commands	:HARDcopy:START :HARDcopy:MODE	
Parameter	PNG	PNG file format
	BMP	BMP file format
Return parameter	Returns the image file format (PNG/BMP).	
Example	:HARDcopy:SAVEFORMat PNG Sets the file format to PNG.	

:HARDcopy:ASSIGN

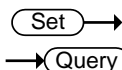

Description	Sets or queries what file type the hardcopy key has been assigned to save.	
Syntax	:HARDcopy:ASSIGN {IMAGe WAVeform SETUp ALL ?}	
Related Commands	:HARDcopy:START :HARDcopy:MODE	
Parameter	IMAGe	Save image files.
	WAVeform	Save waveforms.
	SETUp	Save the panel setup.
	ALL	Save All (image, waveform,setup)
Return parameter	Returns the file type. (IMAGE/WAVEFORM/SETUP/ALL)	
Example	:HARDcopy:ASSIGN IMAGE. Set the hardcopy key to save image files.	

Measure Commands

:MEASure:GATing.....	77
:MEASure:SOURce	77
:MEASure:METHod	78
:MEASUrement:REFLevel:PERCent:HIGH	78
:MEASUrement:REFLevel:PERCent:LOW	79
:MEASUrement:REFLevel:PERCent:MID	79
:MEASUrement:REFLevel:PERCent:MID2	79
:MEASure:FALL.....	80
:MEASure:FOVShoot.....	80
:MEASure:FPReshoot	81
:MEASure:FREQuency	81
:MEASure:NWIDth	82
:MEASure:PDUTy	82
:MEASure:PERiod	83
:MEASure:PWIDth	83
:MEASure:RISe.....	84
:MEASure:ROVShoot.....	84
:MEASure:RPReshoot.....	85
:MEASure:PPULSE.....	86
:MEASure:NPULSE	86
:MEASure:PEDGE	87
:MEASure:NEDGE	87
:MEASure:AMPlitude.....	88
:MEASure:MEAN	88
:MEASure:CMEan	89
:MEASure:HIGH	90
:MEASure:LOW.....	90
:MEASure:MAX.....	91
:MEASure:MIN	91
:MEASure:PK2PK.....	92
:MEASure:RMS	92
:MEASure:CRMS.....	93

:MEASure:AREa	94
:MEASure:CARea	94
:MEASure:FRRDelay	95
:MEASure:FRFDelay.....	95
:MEASure:FFRDelay.....	96
:MEASure:FFFDelay.....	97
:MEASure:LRRDelay	97
:MEASure:LRFDelay.....	98
:MEASure:LFRDelay.....	98
:MEASure:LFFDelay.....	99
:MEASure:PHAsE.....	100

:MEASure:GATing
 Set →
 Query

Description	Sets or queries the measurement gating.	
Syntax	:MEASure:GATing { OFF SCREEn CURSor ? }	
Parameter	OFF	Full record
	SCREEn	Gating set to screen width
	CURSor	Gating between cursors
Return parameter	Returns the gating. (OFF, SCREEN, CURSOR)	
Example	:MEASure:GATing OFF Turns gating off (full record).	

:MEASure:SOURce
 Set →
 Query

Description	Sets or queries the measurement source for source1 or source2.	
Syntax	:MEASure:SOURce<X> { CH1 CH2 CH3 CH4 MATH ? }	
Parameter	<X>	Source1 or source2
	CH1~CH4	Channel 1 to 4

MATH Math

Return parameter Returns the source (CH1, CH2, CH3, CH4, MATH)

Example :MEASure:SOURce1 CH1
Sets source1 to channel 1.

Set →

→ Query

:MEASure:METHOD

Description Sets or queries the method used to determine the High-Low measurement values.

Syntax :MEASure:METHOD { AUTO | HISTogram | MINMax | ? }

Parameter	AUTO	Set to auto.
	HISTogram	Set to the Histogram method.
	MINMax	Set to the Min-Max method.

Return parameter Returns the measurement method (AUTO, HISTOGRAM, MINMAX)

Example :MEASure:METHOD: AUTO
Set the measurement method to auto.

Set →

→ Query

:MEASUrement:REFLevel:PERCent:HIGH

Description Sets or queries the high reference level as a percentage.

Syntax :MEASUrement:REFLevel:PERCent:HIGH {<NRF> | ?}

Parameter	<NRF>	0 - 100%
-----------	-------	----------

Return parameter Returns the high reference level

Example :MEASUrement:REFLevel:PERCent:HIGH 50.1
Set the high reference level to 50.1%.

:MEASUrement:REFLevel:PERCent:LOW



Description	Sets or queries the low reference level as a percentage.
Syntax	:MEASUrement:REFLevel:PERCent:LOW {<NRf> ?}
Parameter	<NRf> 0 - 100%
Return parameter	Returns the low reference level.
Example	:MEASUrement:REFLevel:PERCent:LOW 40.1 Set the low reference level to 40.1%.

:MEASUrement:REFLevel:PERCent:MID



Description	Sets or queries the first mid reference level as a percentage.
Syntax	:MEASUrement:REFLevel:PERCent:MID {<NRf> ?}
Parameter	<NRf> 0 - 100%
Return parameter	Returns the mid reference level.
Example	:MEASUrement:REFLevel:PERCent:MID 50 Set the mid reference level to 50%.

:MEASUrement:REFLevel:PERCent:MID2



Description	Sets or queries the second mid reference level as a percentage.
Syntax	:MEASUrement:REFLevel:PERCent:MID2 {<NRf> ?}
Parameter	<NRf> 0 - 100%
Return parameter	Returns the mid reference level of the second source.
Example	:MEASUrement:REFLevel:PERCent:MID2 50 Set the mid reference level to 50%.

:MEASure:FALL

→ **Query**

Description	Returns the fall time measurement result.	
Syntax	:MEASure:FALL{?}	
Related Commands	:MEASure:SOURce<X>	
Return parameter	<NR3> Chan Off	Indicates the source channel is not activated.
Note	Before using this command, select the measurement channel. See the example below.	
Example	:MEASure:SOURce1 CH1 :MEASure:FALL? Selects Channel 1 as the source, and then measures the fall time.	

:MEASure:FOVShoot

→ **Query**

Description	Returns the fall overshoot amplitude.	
Syntax	:MEASure:FOVShoot{?}	
Related Commands	:MEASure:SOURce<X>	
Return parameter	<NR3> Chan Off	Returns the fall overshoot as a percentage Indicates the source channel is not activated.
Note	Before using this command, select the measurement channel. See the example below.	

Example :MEASure:SOURce1 CH1
 :MEASure:FOVShoot?
 1.27E+0
 Selects Channel 1, and then measures the fall overshoot.

:MEASure:FPReshoot → Query

Description Returns fall preshoot amplitude.

Syntax :MEASure:FPReshoot{?}

Related Commands :MEASure:SOURce<X>

Returns Returns the fall preshoot as <NR3>.

Return parameter	<NR3>	Returns the fall preshoot as a percentage.
	Chan Off	Indicates the source channel is not activated.

Note Before using this command, select the measurement channel. See the example below.

Example :MEASure:SOURce1 CH1
 :MEASure:FPReshoot?
 Selects Channel 1, and then measures the fall preshoot.

:MEASure:FREQuency → Query

Description Returns the frequency value.

Syntax :MEASure:FREQuency{?}

Related Commands :MEASure:SOURce<X>

Return parameter	<NR3>	Returns the frequency in Hz.
	Chan Off	Indicates the source channel is not activated.

Note Before using this command, select the measurement channel. See the example below.

Example :MEASure:SOURce1 CH1
 :MEASure:FREQuency?
 >1.0E+3
 Selects Channel 1, and then measures the frequency.

:MEASure:NWIDth → Query

Description Returns the first negative pulse width timing.

Syntax :MEASure:NWIDth{?}

Related Commands :MEASure:SOURce<X>

Return parameter	<NR3>	Returns the negative pulse width in seconds.
	Chan Off	Indicates the source channel is not activated.

Note Before using this command, select the measurement channel. See the example below.

Example :MEASure:SOURce1 CH1
 :MEASure:NWIDth?
 4.995E-04
 Selects Channel 1, and then measures the negative pulse width.

:MEASure:PDUTy → Query

Description Returns the positive duty cycle ratio as percentage.

Syntax :MEASure:PDUTy{?}

Related commands :MEASure:SOURce<X>

Return parameter	<NR3>	Returns the positive duty ratio.
------------------	-------	----------------------------------

Chan Off	Indicates the source channel is not activated.
----------	--

Note Before using this command, select the measurement channel. See the example below.

Example :MEASure:SOURce1 CH1
 :MEASure:PDUTy?
 5.000E+01
 Selects Channel 1, and then measures the positive duty cycle.

:MEASure:PERiod → Query

Description Returns the period.

Syntax :MEASure:PERiod{?}

Related Commands :MEASure:SOURce<X>

Return parameter <NR3>	Returns the period.
Chan Off	Indicates the source channel is not activated.

Note Before using this command, select the measurement channel. See the example below.

Example :MEASure:SOURce1 CH1
 :MEASure:PERiod?
 1.0E-3
 Selects Channel 1, and then measures the period.

:MEASure:PWIDth → Query

Description Returns the first positive pulse width.

Syntax :MEASure:PWIDth{?}

Related Commands :MEASure:SOURce<X>

Return parameter	<NR3>	Returns the positive pulse width.
	Chan Off	Indicates the source channel is not activated.

Note Before using this command, select the measurement channel. See the example below.

Example :MEASure:SOURce1 CH1
 :MEASure:PWIDth?
 5.0E-6
 Selects Channel 1, and then measures the positive pulse width.

:MEASure:RISe → Query

Description	Returns the first pulse rise time.	
Syntax	:MEASure:RISe{?}	
Related Commands	:MEASure:SOURce<X>	

Return parameter	<NR3>	Returns the rise time.
	Chan Off	Indicates the source channel is not activated.

Note Before using this command, select the measurement channel. See the example below.

Example :MEASure:SOURce1 CH1
 :MEASure:RISe?
 8.5E-6
 Selects Channel 1, and then measures the rise time.

:MEASure:ROVShoot → Query

Description Returns the rising overshoot over the entire waveform in percentage.

Syntax :MEASure:ROVShoot{?}

Related Commands	:MEASure:SOURce<X>	
Return parameter	<NR3>	Returns the overshoot.
	Chan Off	Indicates the source channel is not activated.
Note	Before using this command, select the measurement channel. See the example below.	
Example	:MEASure:SOURce1 CH1 :MEASure:ROVShoot? 5.00E+00 Selects Channel 1, and then measures the rise overshoot.	

:MEASure:RPReshoot → Query

Description	Returns rising preshoot over the entire waveform in percentage.	
Syntax	:MEASure:RPReshoot{?}	
Related Commands	:MEASure:SOURce<X>	
Return parameter	<NR3>	Returns the rising preshoot.
	Chan Off	Indicates the source channel is not activated.
Note	Before using this command, select the measurement channel. See the example below.	
Example	:MEASure:SOURce1 CH1 :MEASure:RPReshoot? 2.13E-2 Selects Channel 1, and then measures the rise preshoot.	

:MEASure:PPULSE

→ Query

Description	Returns the number of positive pulses.	
Syntax	:MEASure:PPULSE{?}	
Related Commands	:MEASure:SOURce<X>	
Return parameter	<NR3>	Returns the number of positive pulses.
	Chan Off	Indicates the source channel is not activated.
Note	Before using this command, select the measurement channel. See the example below.	
Example	:MEASure:SOURce1 CH1 :MEASure:PPULSE? 6.000E+00 Selects Channel 1, and then measures the number of positive pulses.	

:MEASure:NPULSE

→ Query

Description	Returns the number of negative pulses.	
Syntax	:MEASure:NPULSE{?}	
Related Commands	:MEASure:SOURce<X>	
Return parameter	<NR3>	Returns the number of negative pulses.
	Chan Off	Indicates the source channel is not activated.

Note Before using this command, select the measurement channel. See the example below.

Example :MEASure:SOURce1 CH1
 :MEASure:NPULSE?
 4.000E+00
 Selects Channel 1, and then measures the number of negative pulses.

:MEASure:PEDGE → Query

Description Returns the number of positive edges.

Syntax :MEASure:PEDGE{?}

Related Commands :MEASure:SOURce<X>

Return parameter	<NR3>	Returns the number of positive edges.
	Chan Off	Indicates the source channel is not activated.

Note Before using this command, select the measurement channel. See the example below.

Example :MEASure:SOURce1 CH1
 :MEASure:PEDGE?
 1.100E+01
 Selects Channel 1, and then measures the number of positive edges.

:MEASure:NEDGE → Query

Description Returns the number of negative edges.

Syntax :MEASure:NEDGE{?}

Related Commands :MEASure:SOURce<X>

Return parameter	<NR3> Chan Off	Returns the number of negative edges. Indicates the source channel is not activated.
Note	Before using this command, select the measurement channel. See the example below.	
Example	:MEASure:SOURce1 CH1 :MEASure:NEDGE? 1.100E+01 Selects Channel 1, and then measures the number of negative edges.	

:MEASure:AMPlitude → Query

Description	Returns the amplitude difference between the Vhigh-Vlow.	
Syntax	:MEASure:AMPlitude{?}	
Related Commands	:MEASure:SOURce<X>	
Return parameter	<NR3> Chan Off	Returns the amplitude. Indicates the source channel is not activated.
Note	Before using this command, select the measurement channel. See the example below.	
Example	:MEASure:SOURce1 CH1 :MEASure:AMPlitude? 3.76E-3 Selects Channel 1, and then measures the amplitude.	

:MEASure:MEAN → Query

Description	Returns the mean voltage/current of one or more full periods.	
-------------	---	--

Syntax	:MEASure:MEAN{?}	
Related Commands	:MEASure:SOURce<X>	
Return parameter	<NR3>	Returns the mean.
	Chan Off	Indicates the source channel is not activated.
Note	Before using this command, select the measurement channel. See the example below.	
Example	<pre>:MEASure:SOURce1 CH1 :MEASure:MEAN? 1.82E-3</pre> Selects Channel 1, and then measures the mean value.	

:MEASure:CMEan



Description	Returns the mean voltage/current of one full period.	
Syntax	:MEASure:CMEan{?}	
Related Commands	:MEASure:SOURce<X>	
Return parameter	<NR3>	Returns the cyclic mean.
	Chan Off	Indicates the source channel is not activated.
Note	Before using this command, select the measurement channel. See the example below.	
Example	<pre>:MEASure:SOURce1 CH1 :MEASure:CMEan? 9.480E-01</pre> Selects Channel 1, and then measures the mean value of the first period.	

:MEASure:HIGH

→ Query

Description	Returns the global high voltage/current.	
Syntax	:MEASure:HIGH{?}	
Related Commands	:MEASure:SOURce<X>	
Return parameter	<NR3>	Returns the high value.
	Chan Off	Indicates the source channel is not activated.
Note	Before using this command, select the measurement channel. See the example below.	
Example	<pre>:MEASure:SOURce1 CH1 :MEASure:HIGH? 3.68E-3</pre> <p>Selects Channel 1, and then measures the high voltage/current.</p>	

:MEASure:LOW

→ Query

Description	Returns the global low voltage/current.	
Syntax	:MEASure:LOW{?}	
Related Commands	:MEASure:SOURce<X>	
Return parameter	<NR3>	Returns the global low value.
	Chan Off	Indicates the source channel is not activated.
Note	Before using this command, select the measurement channel. See the example below.	

Example :MEASure:SOURce1 CH1
 :MEASure:LOW?
 1.00E-0
 Selects Channel 1, and then measures the low current/voltage.

:MEASure:MAX → Query

Description Returns the maximum amplitude.

Syntax :MEASure:MAX{?}

Related :MEASure:SOURce<X>
 Commands

Return parameter	<NR3>	Returns the maximum amplitude.
	Chan Off	Indicates the source channel is not activated.

Note Before using this command, select the measurement channel. See the example below.

Example :MEASure:SOURce1 CH1
 :MEASure:MAX?
 1.90E-3
 Selects Channel 1, and then measures the maximum amplitude.

:MEASure:MIN → Query

Description Returns the minimum amplitude.

Syntax :MEASure:MIN{?}

Related :MEASure:SOURce<X>
 Commands

Return parameter	<NR3>	Returns the minimum amplitude.
	Chan Off	Indicates the source channel is not activated.

Note Before using this command, select the measurement channel. See the example below.

Example :MEASure:SOURce1 CH1
 :MEASure:MIN?
 -8.00E-3
 Selects Channel 1, and then measures the minimum amplitude.

:MEASure:PK2PK → Query

Description Returns the peak-to-peak amplitude (difference between maximum and minimum amplitude).

Syntax :MEASure:PK2Pk{?}

Related Commands :MEASure:SOURce<X>

Return parameter	<NR3>	Returns the voltage or current peak to peak measurement.
	Chan Off	Indicates the source channel is not activated.

Note Before using this command, select the measurement channel. See the example below.

Example :MEASure:SOURce1 CH1
 :MEASure:PK2Pk?
 2.04E-1
 Selects Channel 1, and then measures the peak-to-peak amplitude.

:MEASure:RMS → Query

Description Returns the root-mean-square voltage/current of one or more full periods.

Syntax :MEASure:RMS{?}

Related Commands	:MEASure:SOURce<X>	
Return parameter	<NR3>	Returns the RMS value.
	Chan Off	Indicates the source channel is not activated.
Note	Before using this command, select the measurement channel. See the example below.	
Example	:MEASure:SOURce1 CH1 :MEASure:RMS? 1.31E-3 Selects Channel 1, and then measures the RMS voltage/current.	

:MEASure:CRMS → **Query**

Description	Returns the root-mean-square voltage/current of one full period.	
Syntax	:MEASure:CRMS{?}	
Related Commands	:MEASure:SOURce<X>	
Return parameter	<NR3>	Returns the CRMS value.
	Chan Off	Indicates the source channel is not activated.
Note	Before using this command, select the measurement channel. See the example below.	
Example	:MEASure:SOURce1 CH1 :MEASure:CRMS? 1.31E-3 Selects Channel 1, and then measures the CRMS voltage/current.	

:MEASure:AREa

→ **Query**

Description	Returns the voltage/current area over one or more full periods.	
Syntax	:MEASure:AREa{?}	
Related Commands	:MEASure:SOURce<X>	
Return parameter	<NR3>	Returns the area value.
	Chan Off	Indicates the source channel is not activated.
Note	Before using this command, select the measurement channel. See the example below.	
Example	:MEASure:SOURce1 CH1 :MEASure:AREa? 1.958E-03 Selects Channel 1, and then measures the area.	

:MEASure:CARea

→ **Query**

Description	Returns the voltage/current area over one full period.	
Syntax	:MEASure:CARea{?}	
Related Commands	:MEASure:SOURce<X>	
Return parameter	<NR3>	Returns the area value.
	Chan Off	Indicates the source channel is not activated.
Note	Before using this command, select the measurement channel. See the example below.	

Example :MEASure:SOURce1 CH1
 :MEASure:CARea?
 1.958E-03
 Selects Channel 1, and then measures the area.

:MEASure:FRRDelay → Query

Description Returns the delay between the first rising edge of source1 and the first rising edge of source2.

Syntax :MEASure:FRRDelay{?}

Related Commands :MEASure:SOURce<X>

Return parameter	<NR3>	Returns the delay.
	Chan Off	Indicates the source channel is not activated.

Note Select the two source channels before entering this command.

Example :MEASure:SOURce1 CH1
 :MEASure:SOURce2 CH2
 :MEASure:FRRDelay?
 -4.68E-6
 Select channel 1 and 2 as source1/2, and then measure FRR.

:MEASure:FRFDelay → Query

Description Returns the delay between the first rising edge of source1 and the first falling edge of source2.

Syntax :MEASure:FRFDelay{?}

Related Commands :MEASure:SOURce<X>

Return parameter	<NR3> Chan Off	Returns the delay. Indicates the source channel is not activated.
Note	Select the two source channels before entering this command.	
Example	<pre>:MEASure:SOURce1 CH1 :MEASure:SOURce2 CH2 :MEASure:FRFDelay? 3.43E-6</pre> <p>Select channel 1 and 2 as source1/2, and then measures FRF.</p>	

:MEASure:FRFDelay



Description	Returns the delay between the first falling edge of source1 and the first rising edge of source2.	
Syntax	:MEASure:FRRDelay{?}	
Related Commands	:MEASure:SOURce<X>	
Return parameter	<NR3> Chan Off	Returns the delay. Indicates the source channel is not activated.
Note	Select the two source channels before entering this command.	
Example	<pre>:MEASure:SOURce1 CH1 :MEASure:SOURce2 CH2 :MEASure:FRRDelay? -8.56E-6</pre> <p>Select channel 1 and 2 as delay source1/2, and then measure FFR.</p>	

:MEASure:FFFDelay → Query

Description Returns the delay between the first falling edge of source1 and the first falling edge of source2.

Syntax :MEASure:FFFDelay{?}

Related Commands :MEASure:SOURce<X>

Return parameter	<NR3>	Returns the delay.
	Chan Off	Indicates the source channel is not activated.

Note Select the two source channels before entering this command.

Example

```
:MEASure:SOURce1 CH1
:MEASure:SOURce2 CH2
:MEASure:FFFDelay?
-8.89E-6
```

Select channel 1 and 2 as delay source1/2, and then measure FFF.

:MEASure:LRRDelay → Query

Description Returns the delay between the first rising edge of source1 and the last rising edge of source2.

Syntax :MEASure:LRRDelay{?}

Related Commands :MEASure:SOURce<X>

Return parameter	<NR3>	Returns the delay.
	Chan Off	Indicates the source channel is not activated.

Note Select the two source channels before entering this command.

Example :MEASure:SOURce1 CH1
 :MEASure:SOURce2 CH2
 :MEASure:LRRDelay?
 -8.89E-6
 Select channel 1 and 2 as delay source1/2, and then measure LRR.

:MEASure:LRFDelay → Query

Description	Returns the delay between the first rising edge of source1 and the last rising edge of source2.	
Syntax	:MEASure:LRFDelay{?}	
Related Commands	:MEASure:SOURce<X>	
Return parameter	<NR3>	Returns the delay.
	Chan Off	Indicates the source channel is not activated.
Note	Select the two source channels before entering this command.	
Example	:MEASure:SOURce1 CH1 :MEASure:SOURce2 CH2 :MEASure:LRFDelay? -4.99E-6 Select channel 1 and 2 as delay source1/2, and then measure LRF.	

:MEASure:LFRDelay → Query

Description	Returns the delay between the first falling edge of source1 and the last rising edge of source2.	
Syntax	:MEASure:LFRDelay{?}	
Related Commands	:MEASure:SOURce<X>	

Return parameter	<NR3>	Returns the delay.
	Chan Off	Indicates the source channel is not activated.

Note Select the two source channels before entering this command.

Example

```
:MEASure:SOURce1 CH1
:MEASure:SOURce2 CH2
:MEASure:LFRDelay?
-9.99E-6
```

Select channel 1 and 2 as delay source1/2, and then measure LFR.

:MEASure:LFFDelay → 

Description Returns the delay between the first falling edge of source1 and the last falling edge of source2.

Syntax :MEASure:LFFDelay{?}

Related Commands :MEASure:SOURce<X>

Return parameter	<NR3>	Returns the delay.
	Chan Off	Indicates the source channel is not activated.

Note Select the two source channels before entering this command.

Example

```
:MEASure:SOURce1 CH1
:MEASure:SOURce2 CH2
:MEASure:LFFDelay?
-9.99E-6
```

Select channel 1 and 2 as delay source1/2, and then measure LFF.

:MEASure:PHase

→ **Query**



Description	Returns the phase between source 1 and source 2.	
Syntax	:MEASure:PHase{?}	
Related Commands	:MEASure:SOURce<X>	
Return parameter	<NR3> Chan Off	Returns the phase difference. Indicates the source channel is not activated.
Note	Select the two source channels before entering this command.	
Example	<pre>:MEASure:SOURce1 CH1 :MEASure:SOURce2 CH2 :MEASure:PHase? 4.50E+01</pre> <p>Select channel 1 and 2 as phase source1/2, and then measure the phase in degrees.</p>	

Measurement Commands

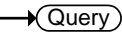
:MEASUrement:MEAS<X>:SOURCE<X>.....101
 :MEASUrement:MEAS<X>:TYPE.....102
 :MEASUrement:MEAS<X>:STATE102
 :MEASUrement:MEAS<X>:VALue.....103
 :MEASUrement:MEAS<X>:MAXimum104
 :MEASUrement:MEAS<X>:MEAN105
 :MEASUrement:MEAS<X>:MINimum105
 :MEASUrement:MEAS<X>:STDdev106
 :MEASUrement:STATIstics:MODE107
 :MEASUrement:STATIstics:WEIghting107
 :MEASUrement:STATIstics108

:MEASUrement:MEAS<X>:SOURCE<X>  

Description	Sets or queries the measurement source for a selected automatic measurement. This is a statistics related command.	
Syntax	:MEASUrement:MEAS<X>:SOURCE<X> { CH1 CH2 CH3 CH4 MATH ? }	
Related commands	:MEASUrement:MEAS<X>:TYPE	
Parameter	MEAS<X>	The automatic measurement number from 1 to 8.
	SOURCE<X>	SOURCE1: the source for all single channel measurements.
	SOURCE<X>	SOURCE2: the source for all delay or phase measurements.
	CH1 to CH4	Channel 1, 2, 3, 4
	MATH	Math source

Return parameter	CH1 to CH4	Channel 1, 2, 3, 4
	MATH	Math source
Example	:MEASUrement:MEAS1:SOURCE1 >CH1 Returns the (first) source for measurement 1.	
		
		

Description Sets or queries the measurement type for a selected automatic measurement. This is a statistics related command.

Syntax :MEASUrement:MEAS<X>:TYPE
 {PK2pk | MAXimum | MINIMUM | AMPLitude | HIGH | LOW | MEAN | CMEan | RMS | CRM s | AREa | CARea | ROVShoot | FOVShoot | RPReshoot | FPReshoot | FREQuency | PERIod | RISE | FALL | PWIdth | NWIdth | PDUTy | PPULSE | NPULSE | PEDGE | NEDGE | FRRDelay | FRFDelay | FFRDelay | FFFDelay | LRRDelay | LRFDelay | LFRDelay | LFFDelay | PHAse | ?}

Related commands :MEASUrement:MEAS<X>:SOURCE<X>

Parameter	MEAS<X>	The automatic measurement number from 1 to 8.
-----------	---------	---

Return parameter Returns the measurement type

Example :MEASUrement:MEAS1:TYPE RMS
 Sets measurement 1 to RMS measurement.

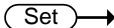

:MEASUrement:MEAS<X>:STATE 

Description Sets or queries the state of a selected measurement. This is a statistics related command.

Syntax :MEASUrement:MEAS<X>:STATE { ON | OFF | 1 | 0 | ? }

Related commands	:MEASUrement:MEAS<X>:SOURce<X> :MEASUrement:MEAS<X>:TYPe	
Parameter	MEAS<X>	The automatic measurement number from 1 to 8.
	ON/1	Turn the measurement on.
	OFF/0	Turn the measurement off.
Return parameter	0	Measurement is off.
	1	Measurement is on.
Example	:MEASUrement:MEAS1:STATE 1 Turns measurement 1 on.	

:MEASUrement:MEAS<X>:VALue → Query

Description	Returns the measurement results for the selected measurement. This is a statistics related command.	
Syntax	:MEASUrement:MEAS<X>:VALue?	
Related Commands	:MEASure:SOURce<X>	
Parameter	MEAS<X>	The automatic measurement number from 1 to 8.
Return parameter	<NR3>	Returns the measurement for the selected measurement number.
Note	The measurement source(s), measurement number, measurement type and measurement state must first be set before a measurement result can be returned.	

Example :MEASUrement:MEAS1:SOUrce1 CH1
 :MEASUrement:MEAS1:TYPe PK2PK
 :MEASUrement:MEAS1:STATE ON
 :MEASUrement:MEAS1:VALue?
 5.000E+0

Selects channel 1 as the source for measurement 1, sets measurement 1 to peak to peak measurement and then turns on the measurement. The result returns the peak to peak measurement.

:MEASUrement:MEAS<X>:MAXimum → **Query**

Description Returns the maximum measurement results for the selected measurement from the last time the statistics were reset. This is a statistics related command.

Syntax :MEASUrement:MEAS<X>:MAXimum?

Related Commands :MEASUrement:STATIstics:MODE

Parameter	MEAS<X>	The automatic measurement number from 1 to 8.
-----------	---------	---

Return parameter	<NR3>	Returns the measurement for the selected measurement number.
------------------	-------	--

Example :MEASUrement:MEAS3:SOUrce1 CH1
 :MEASUrement:MEAS3:TYPe PK2PK
 :MEASUrement:MEAS3:STATE ON
 :MEASUrement:STATIstics:MODE ON
 :MEASUrement:MEAS3:MAXimum?
 2.800E-02

Returns the maximum measurement result for measurement number 3.

:MEASUrement:MEAS<X>:MEAN → Query

Description Returns the mean measurement results for the selected measurement from the last time the statistics were reset. This is a statistics related command.

Syntax :MEASUrement:MEAS<X>:MEAN?

Related Commands :MEASUrement:STATIstics:MODE

Parameter	MEAS<X>	The automatic measurement number from 1 to 8.
------------------	---------	---

Return parameter	<NR3>	Returns the measurement for the selected measurement number.
-------------------------	-------	--

Example

```
:MEASUrement:MEAS3:SOURce1 CH1
:MEASUrement:MEAS3:TYPe PK2PK
:MEASUrement:MEAS3:STATE ON
:MEASUrement:STATIstics:MODE ON
:MEASUrement:MEAS3:MEAN?
2.090E-02
```

Returns the mean measurement result for measurement number 3.

:MEASUrement:MEAS<X>:MINIum → Query

Description Returns the minimum measurement results for the selected measurement from the last time the statistics were reset. This is a statistics related command.

Syntax :MEASUrement:MEAS<X>:MINIum?

Related Commands :MEASUrement:STATIstics:MODE

Parameter	MEAS<X>	The automatic measurement number from 1 to 8.
-----------	---------	---

Return parameter	<NR3>	Returns the measurement for the selected measurement number.
------------------	-------	--

Example

```
:MEASUrement:MEAS3:SOUrce1 CH1
:MEASUrement:MEAS3:TYPe PK2PK
:MEASUrement:MEAS3:STATE ON
:MEASUrement:STATIstics:MODE ON
:MEASUrement:MEAS3:MINImum?
1.600E-02
```

Returns the minimum measurement result for measurement number 3.

:MEASUrement:MEAS<X>:STDdev → **Query**

Description	Returns the standard deviation for the selected measurement from the last time the statistics were reset. This is a statistics related command.
-------------	---

Syntax	:MEASUrement:MEAS<X>:STDdev?
--------	------------------------------

Related Commands	:MEASUrement:STATIstics:MODE
------------------	------------------------------

Parameter	MEAS<X>	The automatic measurement number from 1 to 8.
-----------	---------	---

Return parameter	<NR3>	Returns the measurement for the selected measurement number.
------------------	-------	--

Example :MEASUrement:MEAS3:SOUrce1 CH1
 :MEASUrement:MEAS3:TYPe PK2PK
 :MEASUrement:MEAS3:STATE ON
 :MEASUrement:STATIstics:MODE ON
 :MEASUrement:MEAS3:STDdev?
 1.530E-03
 Returns the standard deviation for measurement number 3.

:MEASUrement:STATIstics:MODE

Set →

→ Query

Description Puts the statics measurement results on the display or queries whether the statistics are displayed.

Syntax :MEASUrement:STATIstics:MODE {OFF | ON | ?}

Related commands :MEASUrement:STATIstics

Parameter/ Return parameter	ON	Display the statistics on the screen.
	OFF	Remove the statistics from the screen

Example :MEASUrement:STATIstics:MODE ON
 Displays statistics on the screen.

:MEASUrement:STATIstics:WEIghing

Set →

→ Query

Description Sets and queries the number of samples (weighting) used for the statistics calculations.

Syntax :MEASUrement:STATIstics:WEIghing { <NR1> | ? }

Parameter/ Return parameter	<NR1>	Number of samples (2~1000)
--------------------------------	-------	----------------------------

Example :MEASUrement:STATIstics:WEIghing 5
 Sets the number of samples to 5.

:MEASUrement:STATIstics**Set** →

Description	Resets the statics calculations. This command will clear all the currently accumulated measurements.
-------------	--

Syntax	:MEASUrement:STATIstics {RESET}
--------	---------------------------------

Reference Commands

:REF<X>:DISPlay.....	109
:REF<X>:TIMebase:POSition	109
:REF<X>:TIMebase:SCALe	110
:REF<X>:OFFSet	110
:REF<x>:SCALe	111

:REF<X>:DISPlay
 Set →
 → Query

Description Sets or queries whether a reference waveform will be shown on the display. A reference waveform must first be saved before this command can be used.

Syntax :REF<x>:DISPlay { OFF| ON | ? }

Parameter	<X>	Reference waveform 1, 2, 3, 4.
	OFF	Turns the selected reference waveform off
	ON	Turns the selected reference waveform on

Return parameter Returns the status of the selected reference waveform. (OFF, ON).

Example :REF1:DISPlay ON
Turns on reference1 (REF 1) on the display.

:REF<X>:TIMebase:POSition
 Set →
 → Query

Description Sets or returns the selected reference waveform time base position.

Syntax :REF<X>:TIMebase:POSition { <NRF> | ? }

Related commands :REF<X>:DISPlay

Parameter	<X>	Reference waveform 1, 2, 3, 4.
	<NRf>	Horizontal co-ordinates

Return parameter	<NR3>	Returns the reference waveform position
------------------	-------	---

Example :REF1:TIMebase:POSition -5.000E-5
 Selects reference 1, and then sets the horizontal position to -50us.

Set →
 → Query

Description	Sets or returns the selected reference waveform time base scale.	
-------------	--	--

Syntax	:REF<X>:TIMebase:SCALe { <NRf> ?}	
--------	-------------------------------------	--

Related commands	:REF<X>:DISPlay	
------------------	-----------------	--

Parameter	<X>	Reference waveform 1, 2, 3, 4.
	<NRf>	Horizontal scale

Return parameter	<NR3>	Returns the reference waveform scale.
------------------	-------	---------------------------------------

Example :REF1:TIMebase:SCALe 5.00E-4
 Selects reference 1, and then sets the horizontal scale to 500us/div.

Set →
 → Query

Description	Sets or returns the selected reference waveform vertical position (offset).	
-------------	---	--

Syntax	:REF<X>:OFFSet { <NRf> ?}	
--------	-----------------------------	--

Related commands	:REF<X>:DISPlay	
------------------	-----------------	--

Parameter	<X>	Reference waveform 1, 2, 3, 4.
	<NRf>	Vertical offset

Return parameter <NR3> Returns the reference waveform vertical position.

Example :REF1:OFFSet -5.000E-2
 Selects reference 1, and then sets the vertical position to -50mV/mA.

:REF<x>:SCALE  

Description Sets or returns the selected reference waveform vertical scale.

Syntax :REF<X>:SCALE { <NRf> | ? }

Related commands :REF<X>:DISPlay

Parameter <X> Reference waveform 1, 2, 3, 4.
 <NRf> Vertical scale

Return parameter <NR3> Returns the reference waveform vertical scale.

Example :REF1:SCALE 5.000E-2
 Selects reference 1, and then sets the vertical scale to 50mV | mA/div.

Run Command

:RUN



Description	The run command allows the oscilloscope to continuously make acquisitions (equivalent to pressing the Run key on the front panel).
-------------	--

Syntax	:RUN
--------	------

Stop Command

:STOP



Description	The stop command stops the oscilloscope making further acquisitions (equivalent to pressing the Stop key on the front panel).
-------------	---

Syntax	:STOP
--------	-------

Single Command

:SINGle



Description	The single command allows the oscilloscope to capture a single acquisition when trigger conditions have been fulfilled (equivalent to pressing the Single key on the front panel).
-------------	--

Syntax	:SINGle
--------	---------

Force Command

:FORCe



Description	The Force command forces an acquisition (equivalent to pressing the Force-Trig key on the front panel).
-------------	---

Syntax	:FORCe
--------	--------

Timebase Commands

:TIMebase:EXPand	114
:TIMebase:POSition	114
:TIMebase:SCALe	114
:TIMebase:MODE	115
:TIMebase:WINDow:POSition	115
:TIMebase:WINDow:SCALe	116

:TIMebase:EXPand (Set) →
→ (Query)

Description	Sets or queries the horizontal expansion mode.	
Syntax	:TIMebase:EXPand {CENTer TRIGger ?}	
Parameter/Return parameter	CENTer	Expand from the center of the display.
	TRIGger	Expand from the trigger point.
Example	:TIMebase:EXPand TRIGger Sets the expansion point to the trigger point.	

:TIMebase:POSition (Set) →
→ (Query)

Description	Sets or queries the horizontal position.	
Syntax	:TIMebase:POSition {<NRf> ?}	
Parameter	<NRf>	Horizontal position
Return parameter	<NR3>	Returns the horizontal position
Example	:TIMebase:POSition 5.00E-4 Sets the horizontal position as 500us.	

:TIMebase:SCALe (Set) →
→ (Query)

Description	Sets or queries the horizontal scale.	
-------------	---------------------------------------	--

Syntax	:TIMebase:SCALE {<NRf> ?}	
Parameter	<NRf>	Horizontal scale
Return parameter	<NR3>	Returns the horizontal scale.
Example	:TIMebase:SCALE 5.00E-2 Sets the horizontal scale to 50ms/div.	

Set →

:TIMebase:MODE

→ Query

Description	Sets or queries the time base mode. The time base mode determines the display view window on the scope.	
Syntax	:TIMebase:MODE {MAIN WINDow XY ?}	
Parameter	MAIN	Sets the time base mode to the main screen.
	WINDow	Sets the time base mode to the zoom window.
	XY	Sets the time base mode to the XY display.
Return parameter	Returns the time base mode (MAIN, WINDOW, XY)	
Example	:TIMebase:MODE MAIN Sets the time base mode to the main mode.	

Set →

:TIMebase:WINDow:POSition

→ Query

Description	Sets or queries the zoom horizontal position.	
Syntax	:TIMebase:WINDow:POSition {<NRf> ?}	
Related commands	:TIMebase:MODE	
Parameter	<NRf>	Horizontal position for zoom window
Return parameter	<NR3>	Returns the zoom horizontal position.

Example :TIMebase:WINDow:POSition 2.0E-3
 Sets the zoom horizontal position as 20ms.

Set →

:TIMebase:WINDow:SCALE

→ Query

Description	Sets or queries the zoom horizontal scale.	
Note	If the oscilloscope is under “ZOOM” mode, the main timebase function will be disabled and cannot be modified.	
Syntax	:TIMebase:WINDow:SCALE {<NRf> ?}	
Related commands	:TIMebase:MODE	
Parameter	<NRf>	Zoom horizontal scale. The range will depend on the time base.
Return parameter	<NR3>	Returns the zoom horizontal scale.
Example	:TIMebase:WINDow:SCALE 2.0E-3 Sets the zoom horizontal scale to 2ms.	

Trigger Commands

:TRIGger:FREQuency.....	118
:TRIGger:TYPe.....	118
:TRIGger:SOURce	119
:TRIGger:COUPle.....	119
:TRIGger:NREJ	119
:TRIGger:MODE.....	120
:TRIGger:HOLDoff.....	120
:TRIGger:LEVel.....	120
:TRIGger:HLEVel.....	121
:TRIGger:LLEVel.....	121
:TRIGger:EDGe:SLOP	122
:TRIGger:DELaY:SLOP	122
:TRIGger:DELaY:TYPe	123
:TRIGger:DELaY:TIME.....	123
:TRIGger:DELaY:EVENt.....	123
:TRIGger:DELaY:LEVel	124
:TRIGger:PULSEWidth:POLarity.....	124
:TRIGger:RUNT:POLarity	125
:TRIGger:RUNT:WHEn.....	125
:TRIGger:RUNT:TIME	126
:TRIGger:RISEFall:SLOP	126
:TRIGger:RISEFall:WHEn	126
:TRIGger:RISEFall:TIME.....	127
:TRIGger:VIDeo:TYPe	127
:TRIGger:VIDeo:FIELD	128
:TRIGger:VIDeo:LINE.....	129
:TRIGger:VIDeo:POLarity	129
:TRIGger:PULSe:WHEn	129
:TRIGger:PULSe:TIME	130
:TRIGger:TIMEOut:WHEn.....	130
:TRIGger:TIMEOut:TIMER	131
:TRIGger:ALTErnate	131

:TRIGger:STATe131
 :TRIGger:EXTERnal:PROBE:TYPe.....132
 :TRIGger:EXTERnal:PROBE:RATio133

:TRIGger:FREQuency → Query

Description	Queries the trigger frequency.
Syntax	:TRIGger:FREQuency{?}
Return parameter	<NR3> Returns the trigger frequency.
Example	:TRIGger:FREQuency? 1.032E+3 Returns the trigger frequency.

Set →

:TRIGger:TYPe → Query

Description	Sets or queries the trigger type.
Syntax	:TRIGger:TYPe {EDGE DELay PULSEWidth VIDEo RUNT RISEFall TIMEOut ? }
Parameter	EDGE Edge trigger DELay Delay trigger PULSEWidth Pulse width trigger VIDeo Video trigger RUNT Runt trigger RISEFall Rise and fall trigger TIMEOut Timeout trigger
Return parameter	Returns the trigger type.
Example	:TRIGger:TYPe EDGE Sets the trigger type to edge.

:TRIGger:SOURce



Description	Sets or queries the trigger source.	
Syntax	:TRIGger:SOURce { CH1 CH2 CH3 CH4 EXT LINE ? }	
Parameter	CH1 to CH4	Channel 1 to channel 4
	EXT	External source
	LINE	AC Line
Return parameter	Returns the trigger source.	
Example	:TRIGger:SOURce CH1 Sets the trigger source to channel 1.	

:TRIGger:COUple



Description	Sets or queries the trigger coupling.	
Note	Applicable for edge and delay triggers only.	
Syntax	:TRIGger:COUple {AC DC HF LF ?}	
Parameter	AC	AC mode
	DC	DC mode
	HF	High frequency rejection
	LF	Low frequency rejection
Return parameter	Returns the trigger coupling.	
Example	:TRIGger:COUple AC Sets the trigger coupling to AC.	

:TRIGger:NREJ



Description	Sets or queries noise rejection status.	
Syntax	:TRIGger:NREJ {OFF ON ?}	

Parameter	OFF	Turns noise rejection off
	ON	Turns noise rejection on

Return parameter Returns the noise rejection status (ON, OFF).

Example :TRIGger:NREJ ON
Turns noise rejection on.

Set →
 → Query

Description Sets or queries the trigger mode.

Syntax :TRIGger:MODE {AUTo | NORMal | ?}

Parameter	AUTo	Auto trigger (Untriggered roll)
	NORMal	Normal trigger

Return parameter Returns the trigger mode.

Example :TRIGger:MODE NORMal
Sets the trigger mode to normal.

Set →
 → Query

Description Sets or queries the holdoff time.

Syntax :TRIGger:HOLDoff {<NRf> | ?}

Parameter	<NRf>	Holdoff time
-----------	-------	--------------

Return parameter <NR3> Returns the trigger holdoff time.

Example :TRIGger:HOLDoff 1.00E-8
Sets the trigger holdoff time to 10ns.

Set →
 → Query

Description Sets or queries the level.

Note Not applicable to Pulse Runt and Rise & Fall triggers.

Syntax	:TRIGger:LEVel {TTL ECL SETTO50 <NRf> ?}	
Related commands	:TRIGger:TYPe	
Parameter	<NRf>	Trigger level value.
	TTL	Sets the trigger level to TTL.
	ECL	Sets the trigger level to ECL.
	SETTO50	Sets the trigger level to the User level (50% by default).
Return parameter	<NR3>	Returns the trigger level.
Example1	:TRIGger:LEVel TTL Sets the trigger to TTL.	
Example2	:TRIGger:LEVel 3.30E-1 Sets the trigger level to 330mV/mA.	

:TRIGger:HLEVel

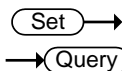

Description	Sets or queries the high trigger level.	
Note	Applicable for Rise and Fall/Pulse Runt triggers.	
Syntax	:TRIGger:HLEVel {<NRf> ?}	
Related commands	:TRIGger:TYPe	
Parameter	<NRf>	High level value.
Return parameter	<NR3>	Returns the trigger high level.
Example	:TRIGger:HLEVel 3.30E-1 Sets the trigger high level to 330mV/mA.	

:TRIGger:LLEVel

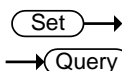

Description	Sets or queries the low trigger level.	
Note	Applicable for Rise and Fall/Pulse Runt triggers.	

Syntax	:TRIGger:LLEVel {<NRf> ?}	
Related commands	:TRIGger:TYPe	
Parameter	<NRf>	Low level value.
Return parameter	<NR3>	Returns the trigger low level.
Example	:TRIGger:LLEVel -3.30E-3 Sets the trigger low level to -330mV/mA.	

Set →

→ Query

:TRIGger:EDGE:SLOP

Description	Sets or queries the trigger slope.	
Syntax	:TRIGger:EDGE:SLOP {RISe FALL EITHer ? }	
Related commands	:TRIGger:TYPe	
Parameter	RISe	Rising slope
	FALL	Falling slope
	EITHer	Either rising or falling slope
Return parameter	Returns the trigger slope.	
Example	:TRIGger:EDGE:SLOP FALL Sets the trigger slope to falling.	

Set →

→ Query

:TRIGger:DELAy:SLOP

Description	Sets or queries the trigger slope for the delay trigger.	
Syntax	:TRIGger:DELAy:SLOP {RISe FALL EITHer ? }	
Related commands	:TRIGger:TYPe	
Parameter	RISe	Rising slope
	FALL	Falling slope
	EITHer	Either rising or falling slope

Return parameter Returns the trigger slope.

Example :TRIGger:DElay:SLOP FALL
Sets the trigger slope to falling.

Set →

→ Query

:TRIGger:DElay:TYPE

Description Sets or queries the trigger delay type.

Syntax :TRIGger:DElay:TYPE {TIME | EVENT | ?}

Related commands :TRIGger:TYPE

Parameter	TIME	Sets the delay type to time.
	EVENT	Sets the delay type to event.

Return parameter Returns the trigger delay type.

Example :TRIGger:DElay:TYPE TIME
Sets the delay type to time delay.

Set →

→ Query

:TRIGger:DElay:TIME

Description Sets or queries the delay time value.

Syntax :TRIGger:DElay:TIME {<NRf> | ?}

Related commands :TRIGger:DElay:TYPE

Parameter	<NRf>	Delay time (1.00E-8~1.00E+1)
-----------	-------	------------------------------

Return parameter	<NR3>	Returns the delay time.
------------------	-------	-------------------------

Example :TRIGger:DElay:TIME 1.00E-6
Sets the delay time to 1us.

Set →

→ Query

:TRIGger:DElay:EVENT

Description Sets or queries the number of events for the event delay trigger.

Syntax	:TRIGger:DELAy:EVENT {<NR1> ?}	
Related commands	:TRIGger:DELAy:TYPe	
Parameter	<NR1>	1~65535 events
Return parameter	<NR1>	Returns the number of events.
Example	:TRIGger:DELAy:EVENT 2 Sets the number of events to 2.	

Set →
 → Query

Description	Sets or queries the trigger delay level.	
Syntax	:TRIGger:DELAy:LEVEl {<NRf> ?}	
Parameter	<NRf>	Delay trigger level
Return parameter	<NR3>	Returns the delay trigger.
Example	:TRIGger:DELAy:LEVEl 5.00E-3 Sets the delay trigger level to 5mV/ mA.	

Set →
 → Query

Description	Sets or queries the pulse width trigger polarity.	
Syntax	:TRIGger:PULSEWidth:POLarity {POSitive NEGative ?}	
Related commands	:TRIGger:TYPe	
Parameter	POSitive	Positive polarity
	NEGative	Negative polarity
Return parameter	Returns the pulse width polarity.	
Example	:TRIGger:PULSEWidth:POLarity POSitive Sets the pulse width polarity to positive.	

:TRIGger:RUNT:POLarity



Description	Sets or queries the Pulse Runt trigger polarity.	
Syntax	:TRIGger:RUNT:POLarity { POSitive NEGative EITher ? }	
Related commands	:TRIGger:TYPE	
Parameter	POSitive	Positive polarity
	NEGative	Negative polarity
	EITher	Positive or negative polarity
Return parameter	Returns the pulse runt trigger polarity.	
Example	:TRIGger:RUNT:POLarity POSitive Sets the Pulse Runt trigger polarity to positive.	

:TRIGger:RUNT:WHEn



Description	Sets or queries the Pulse Runt trigger conditions.	
Syntax	:TRIGger:RUNT:WHEn { MOREthan LESSthan EQual UNEQual ? }	
Related commands	:TRIGger:TYPE :TRIGger:RUNT:TIME	
Parameter	MOREthan	>
	LESSthan	<
	EQual	=
	UNEQual	≠
Return parameter	Returns the pulse runt trigger condition.	
Example	:TRIGger:RUNT:WHEn UNEQual Sets the Pulse Runt trigger condition to unequal (≠).	

Set →
 → Query

:TRIGger:RUNT:TIME

Description	Sets or queries the Pulse Runt trigger time.	
Syntax	:TRIGger:RUNT:TIME {<NRf> ? }	
Related commands	:TRIGger:TYPe :TRIGger:RUNT:WHEn	
Parameter	<NRf>	Pulse runt time (4nS to 10S)
Return Parameter	<NR3>	Returns the runt time in seconds
Example	:TRIGger:RUNT:TIME 4.00E-5 Sets the runt time to 40.0uS.	

Set →
 → Query

:TRIGger:RISEFall:SLOP

Description	Sets or queries the Rise & Fall slope.	
Syntax	:TRIGger:RISEFall:SLOP {RISe FALL EITHer ? }	
Parameter	RISe	Rising slope
	FALL	Falling slope
	EITHer	Either rising or falling slope
Return parameter	Returns the rise & fall slope.	
Example	:TRIGger:RISEFall:SLOP RISe Sets the Rise & Fall slope to rising.	

Set →
 → Query

:TRIGger:RISEFall:WHEn

Description	Sets or queries the rise/fall trigger conditions.	
Syntax	:TRIGger:RISEFall:WHEn {MOREthan LESSthan EQual UNEQual ? }	
Related commands	:TRIGger:TYPe :TRIGger:RISEFall:TIME	

Parameter	MOREthan	>
	LESSthan	<
	Equal	=
	UNEQual	≠

Return parameter Returns the rise/fall trigger condition.

Example :TRIGger:RISEFall:WHEn UNEQual
Sets the Rise and Fall trigger condition to unequal (≠).

:TRIGger:RISEFall:TIME (Set) →
→ (Query)

Description Sets or queries the Rise and Fall time.

Syntax :TRIGger:RISEFall:TIME {<NRf> | ? }

Related commands :TRIGger:TYPe
:TRIGger:RISEFall:WHEn

Parameter	<NRf>	Rise and Fall time (4nS to 10S)
Return Parameter	<NR3>	Returns the rise and fall time in seconds

Example :TRIGger:RISEFall:TIME 4.00E-5
Sets the trigger rise & fall to 40.0us.

:TRIGger:VIDeo:TYPe (Set) →
→ (Query)

Description Sets or queries the video trigger type.

Syntax :TRIGger:VIDeo:TYPe {NTSC | PAL | SECam | EDTV480P | EDTV576P | HDTV720P | HDTV1080I | HDTV1080P | ? }

Related commands :TRIGger:TYPe

Parameter	NTSC	NTSC
	PAL	PAL
	SECAM	SECAM
	EDTV480P	Extra definition TV 480P
	EDTV576P	Extra definition TV 576P
	HDTV720P	High definition TV 720P
	HDTV1080I	High definition TV 1080i
	HDTV1080P	High definition TV 1080P

Return parameter Returns the video trigger type.

Example :TRIGger:VIDeo:TYPe NTSC
 Sets the video trigger to NTSC.

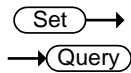

:TRIGger:VIDeo:FIELD

Description Sets or queries the video trigger field.

Syntax :TRIGger:VIDeo:FIELD { FIELD1 | FIELD2 | ALLFields | ALLLines | ? }

Related commands :TRIGger:TYPe

Parameter	FIELD1	Trigger on field 1
	FIELD2	Trigger on field 2
	ALLFields	Trigger on all fields
	ALLLines	Trigger on all lines

Return parameter Returns the video trigger field.

Example :TRIGger:VIDeo:FIELD ALLFields
 Sets the video trigger to trigger on all fields.

Set →
→ Query

:TRIGger:VIDeo:LIne	
Description	Sets or queries the video trigger line.
Syntax	:TRIGger:VIDeo:LIne {<NR1> ?}
Related commands	:TRIGger:TYPE
Parameter	<NR1> Video line
Return parameter	<NR3> Returns the video trigger line.
Example	:TRIGger:VIDeo:LIne 1 Sets the video trigger to line 1.

Set →
→ Query

:TRIGger:VIDeo:POLarity	
Description	Sets or queries the video trigger polarity.
Syntax	:TRIGger:VIDeo:POLarity { POSitive NEGative ? }
Related commands	:TRIGger:TYPE
Parameter	POSitive Positive polarity NEGative Negative polarity
Return parameter	Returns the video trigger polarity.
Example	:TRIGger:VIDeo:POLarity POSitive Sets the video trigger polarity to positive.

Set →
→ Query

:TRIGger:PULSe:WHEn	
Description	Sets or queries the pulse width trigger conditions.
Syntax	:TRIGger:PULSe:WHEn { MOREthan LESSthan EQUAL UNEQUAL ? }
Related commands	:TRIGger:TYPE :TRIGger:PULSe:TIME

Parameter	MORE than	>
	LESSthan	<
	Equal	=
	UNEQual	≠

Return parameter Returns the pulse width trigger conditions.

Example :TRIGger:PULSe:WHEn UNEQual
 Sets the trigger pulse width conditions to not equal to (≠).

Set →
 → Query

Description Sets or queries the pulse width time.

Syntax :TRIGger:PULSe:TIME {<NRf> | ?}

Related commands :TRIGger:TYPe
 :TRIGger:PULSe:WHEn

Parameter	<NRf>	Pulse width time (4ns~10s)
-----------	-------	----------------------------

Return parameter	<NR3>	Returns the pulse width time in seconds.
------------------	-------	--

Example :TRIGger:PULSe:TIME 4.00E-5
 Sets the trigger pulse width to 40.0us.

Set →
 → Query

Description Sets or queries the timeout trigger condition.

Syntax :TRIGger:TIMEOut:WHEn {HIGH|LOW|EITHer|?}

Related commands :TRIGger:TIMEOut:TIMER

Parameter	HIGH	Signal is high.
	LOW	Signal is low.
	EITHer	Signal is high or low.

Return parameter Returns the timeout condition (HIGH, LOW, EITHER).

Example1 :TRIGger:TIMEOut:WHEn LOW
Sets the timeout condition to low.

:TRIGger:TIMEOut:TIMER

Set →

→ Query

Description Sets or returns timeout trigger time.

Syntax :TRIGger:TIMEOut:TIMER {<NRf> | ?}

Related commands :TRIGger:TIMEOut:WHEn

Parameter <NRf> Timeout time. (4nS to 10S).

Return parameter Returns the timeout time as <NR3>.

Example :TRIGger:TIMEOut:TIMER?
8.960e-05

Set →

→ Query

:TRIGger:ALternate

Description Sets alternating between source triggers on or off or queries its state.

Syntax :TRIGger:ALternate {OFF | ON |?}

Parameter OFF Alternate off
ON Alternate on

Return parameter Returns the Alternate trigger status (ON, OFF).

Example :TRIGger:ALternate ON
Turns on alternating between source triggers.

:TRIGger:STATE

→ Query

Description Returns the current state of the triggering system.

Syntax :TRIGger:STATE?

Return parameter	*ARMED	Indicates that the oscilloscope is acquiring pretrigger information.
	*AUTO	Indicates that the oscilloscope is in the automatic mode and acquires data even in the absence of a trigger.
	*READY	Indicates that all pretrigger information has been acquired and that the oscilloscope is ready to accept a trigger.
	*SAVE	Indicates that the oscilloscope is in save mode and is not acquiring data.
	*TRIGGER	Indicates that the oscilloscope triggered and is acquiring the post trigger information.

Example :TRIGger:STATe?
 AUTO
 The trigger is in auto mode.

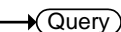
:TRIGger:EXTERnAl:PROBE:TYPE  

Description	Sets or queries the external probe type.	
Syntax	:TRIGger:EXTERnAl:PROBE:TYPE { VOLTage CURRent ? }	
Related commands	:TRIGger:EXTERnAl:PROBE:RATio	
Parameter	VOLTage	Voltage
	CURRent	Current
Return parameter	Returns the probe type.	
Example	:TRIGger:EXTERnAl:PROBE:TYPE? CURRENT	

:TRIGger:EXTERnal:PROBe:RATio

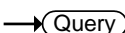

Description	Sets or queries the external probe ratio (attenuation).	
Syntax	:TRIGger:EXTERnal:PROBe:RATio {<NRf> ?}	
Related commands	:TRIGger:EXTERnal:PROBe:TYPe	
Parameter	<NRf>	External probe attenuation factor.
Return parameter	<NR3>	Returns the probe attenuation factor.
Example	:TRIGger:EXTERnal:PROBe:RATio? 5.000000e+01	

System Commands

:SYSTem:LOCK	134
:SYSTem:ERRor	134

:SYSTem:LOCK



Description	Turns the panel lock on off.	
Syntax	:SYSTem:LOCK {OFF ON ? }	
Parameter	OFF	System lock off
	ON	System lock on
Return parameter	Returns the status of the panel lock (ON, OFF).	
Example	:SYSTem:LOCK ON Turns the panel lock on.	

:SYSTem:ERRor





Description	Queries the error queue. See the appendix on page 161 for details.	
Syntax	:SYSTem:ERRor?	
Return parameter	Returns the last message in the error queue.	
Example	:SYSTem:ERRor? +0, "No error."	

Save/Recall Commands

:RECALL:SETUp	135
:RECALL:WAVEform	135
:SAVe:IMAGe	136
:SAVe:IMAGe:FILEFormat	136
:SAVe:IMAGe:INKSaver	137
:SAVe:SETUp	137
:SAVe:WAVEform	138
:SAVe:WAVEform:FILEFormat	139

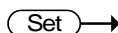
:RECALL:SETUp



Description	Recalls setup settings from memory or USB.	
Syntax	:RECALL:SETUp {S1~S20 <file path>("Disk:/xxx.SET", "USB:/xxx.SET")}	
Parameter	S1~S20	Recall Set1~Set20
	<file path>	Recall a file from the DSO internal files system or from a USB flash drive.
Example	:RECALL:SETUp S1 Recalls setup setting S1 from memory. :RECALL:SETUp "Disk:/DS0001.SET" Recall the setup setting DS0001.SET from the internal memory.	

:RECALL:WAVEform



Description	Recalls a waveform from wave1~wave20 or from file to REF1~4.
Note	Detail CSV files cannot be recalled.
Syntax	:RECALL:WAVEform {W<n> <file path> ("Disk:/xxx.LSF", "USB:/xxx.LSF")}, REF<X>

Parameter	n	1~20 (Wave1~wave20)
	<file page>	Filename in file path. Example: "Disk:/xxx.LSF", "USB:/xxx.LSF", "Disk:/xxx.CSV", "USB:/xxx.CSV"
	<X>	1,2,3,4 (REF1, REF2, REF3, REF4)

Example :RECALL:WAVEform W1, REF1
 Recalls the waveform stored in Wave1 to reference 1.

:SAVE:IMAGe



Description Saves a screen image to the assigned file path with a specified filename.

Syntax :SAVE:IMAGe {<file path> ("Disk:/xxx.PNG", "USB:/xxx.BMP")}

Related commands :SAVE:IMAGe:FILEFormat
 :SAVE:IMAGe:INKSaver

Parameter	xxx.PNG or xxx.BMP	File name (8 characters max)
-----------	--------------------	------------------------------

Example :SAVE:IMAGe "Disk:/pic1.PNG"
 Saves a screen image named pic1.png to the root directory (Disk:/) of the scope.
 :SAVE:IMAGe "USB:/pic1.BMP"
 Saves a screen image named pic1.bmp to the root directory of the external USB flash disk.

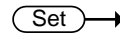

:SAVE:IMAGe:FILEFormat



Description Sets the file format for image.

Syntax :SAVE:IMAGe:FILEFormat {PNG | BMP | ?}

Related commands :SAVE:IMAGe
 :SAVE:IMAGe:INKSaver

Parameter	PNG	Sets the file format to PNG
	BMP	Sets the file format to BMP

Return parameter Returns the file format (PNG, BMP).

Example :SAVE:IMAGE:FILEFormat PNG
Sets the image file format to PNG.

:SAVE:IMAGE:INKSaver

Set →

→ Query

Description Turns Ink Saver on or off.

Syntax :SAVE:IMAGE:INKSaver {OFF | ON |?}

Related commands :SAVE:IMAGE
:SAVE:IMAGE:FILEFormat

Parameter	OFF	Turns Inksaver off.
	ON	Turns Inksaver on.

Return parameter Returns Ink Saver status (ON, OFF).

Example :SAVE:IMAGE:INKSaver ON
Turns Ink Saver on.

:SAVE:SETUp

Set →

Description Saves the current setup to internal memory (Set1~Set20) or the designated file path.

Syntax :SAVE:SETUp {<file path> ("Disk:/xxx.SET", "USB:/xxx.SET) | S1~S20}

Parameter	S1~S20	Saves the setup to Set1~Set20
	File path	Saves the setup to disk to the specified file path.

Example :SAVe:SETUp S1
 Saves the current setup to Set1 in internal memory.
 :SAVe:SETUp "Disk:/DS0001.SET"
 Saves the current setup to DS0001.SET in the root directory of the internal memory.

:SAVe:WAVEform



Description	Saves a waveform to internal memory or to a designated file path.	
Related commands	:SAVe:WAVEform:FILEFormat	
Syntax	:SAVe:WAVEform {CH1~REF4, REF<X> } {CH1~REF4, W1~W20} {CH1~ALL, file path}	
Parameter	CH1~REF4	CH1~CH4, Math, REF1~4
	<X>	1,2,3,4 (REF1, REF2, REF3, REF4)
	W1~W20	Wave1~Wave20
	ALL	All the displayed waveforms on screen.
	File path	Saves the waveform(s) to disk or USB to the specified file path. (LSF or CSV, but note that detail CSV can't be recalled to the scope.)
Example 1	:SAVe:WAVEform CH1, REF2 Saves the channel1 waveform to REF2.	
Example 2	:SAVe:WAVEform:FILEFormat LSF :SAVe:WAVEform ALL, "Disk:/ALL001" Sets the file format to LSF. A folder named "ALL001" is created and saves all displayed waveforms to the "ALL001" directory in the LSF format.	

Example 3 :SAVe:WAVEform:FILEFormat FCSV
 :SAVe:WAVEform ALL, "Disk:/ALL002"
 Sets the file format to FCSV(fast CSV format). It then saves the all channel's waveforms to the root directory (Disk:/) of the internal flash disk in the CSV format (with the filename ALL002.CSV).

Example 4 :SAVe:WAVEform:FILEFormat LSF
 :SAVe:WAVEform CH2, "Disk:/DS0003.LSF"
 Save the channel 2's waveform to the root directory (Disk:/) of the internal flash disk in the LSF format with DS0003.LSF as the filename.

:SAVe:WAVEform:FILEFormat



Description	Sets the waveform savefile format.	
Syntax	:SAVe:WAVEform:FILEFormat {LSF DCSV FCSV ?}	
Parameter	LSF	Sets the file format to the GDS 1000B's internal file format, LSF. (xxx.LSF)
	DCSV	Sets the file format to detail CSV. (xxx.CSV)
	FCSV	Sets the file format to fast CSV. (xxx.CSV)

Return parameter Returns the file format (LSF, DCSV, FCSV).

Example :SAVe:WAVEform:FILEFormat LSF
 Sets the file format to LSF.

Ethernet Commands

:ETHERnet:DHCP140

:ETHERnet:DHCP
 →
 →

Description	Sets or queries the DHCP settings.	
Note	The Ethernet commands are only applicable to GDS-1074B & GDS-1104B.	
Syntax	:ETHERnet:DHCP { OFF ON ? }	
Parameter	ON	Turns DHCP on.
	OFF	Turns DHCP off.
Example	:ETHERnet:DHCP ON Turns DHCP on.	

Label Commands

:CHANnel<X>:LABel.....	141
:CHANnel<X>:LABel:DISPlay.....	142
:REF<X>:LABel.....	142
:REF<X>:LABel:DISPlay.....	143
:SET<X>:LABel.....	144

:CHANnel<X>:LABel

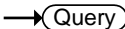

Description	Sets or returns the file label for the selected channel.	
Syntax	:CHANnel<X>:LABel {<string> ?}	
Related commands	:CHANnel<X>:LABel:DISPlay	
Parameter	<X>	Channel 1, 2, 3, 4
	<string>	The string must be no more than 8 characters and only contain alphanumeric characters in addition to period, dash and underscore characters. The string must be enclosed in double quotes, "string".
Return parameter	<string>	Returns the label for the selected channel. No return indicates that there has not been a file label assigned for the selected channel.
Example1	:CHANnel1:LABel "CH1_lab" Sets the channel 1 label as "CH1_lab".	
Example2	:CHANnel1:LABel? CH1_lab	

:CHANnel<X>:LABel:DISPlay							
 							
Description	Turns the label on/off for the selected channel or returns its status.						
Syntax	:CHANnel<X>:LABel:DISPlay { OFF ON ? }						
Related commands	:CHANnel<X>:LABel						
Parameter	<table border="1" style="width: 100%; border-collapse: collapse;"> <tr> <td style="width: 15%;"><X></td> <td>Channel 1, 2, 3, 4</td> </tr> <tr> <td>OFF</td> <td>Turns the file label off for the selected channel.</td> </tr> <tr> <td>ON</td> <td>Turns the file label on for the selected channel.</td> </tr> </table>	<X>	Channel 1, 2, 3, 4	OFF	Turns the file label off for the selected channel.	ON	Turns the file label on for the selected channel.
<X>	Channel 1, 2, 3, 4						
OFF	Turns the file label off for the selected channel.						
ON	Turns the file label on for the selected channel.						
Return parameter	Returns the status of the file label for the selected channel (ON, OFF).						
Example	<pre>:CHANnel1:LABel "CH1" :CHANnel1:LABel:DISPlay ON :CHANnel1:LABel:DISPlay? ON</pre> <p>Sets the channel 1 label to "CH1" and then turns the label display on. The query return shows that the label is on.</p>						

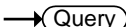
:REF<X>:LABel	
 	
Description	Sets or returns the file label for the selected reference waveform.
Syntax	:REF<X>:LABel {<string> ?}
Related commands	:REF<X>:LABel:DISPlay

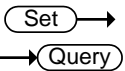
Parameter	<X> <string>	REF 1, 2, 3, 4 The string must be no more than 8 characters and only contain alphanumeric characters in addition to period, dash and underscore characters. The string must be enclosed in double quotes, "string".
Return parameter	<string>	Returns the label for the selected reference waveform. No return indicates that there has not been a file label assigned for the selected reference waveform.
Example1	:REF1:LABel "REF1_lab" Sets the REF1 label as "REF1_lab".	
Example2	:REF1:LABel? REF1_lab	
	:REF<X>:LABel:DISPlay	 <p>The diagram shows a rounded rectangle labeled 'Set' with an arrow pointing to the right, and another rounded rectangle labeled 'Query' with an arrow pointing to the left, indicating that the command can be used to set or query the label status.</p>
Description	Turns the label on/off for the selected reference waveform or returns its status.	
Syntax	:REF<X>:LABel:DISPlay { OFF ON ? }	
Related commands	:REF<X>:LABel	
Parameter	<X> OFF ON	Reference waveform 1, 2, 3, 4 Turns the file label off for the selected reference waveform. Turns the file label on for the selected reference waveform.
Return parameter	Returns the status of the file label for the selected reference waveform (ON, OFF).	

Example :REF1:LABel "REF1"
 :REF1:LABel:DISPlay ON
 :REF1:LABel:DISPlay?
 ON

Sets the label for reference waveform 1 to "REF1" and then turns the label display on. The query return shows that the label is on.

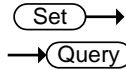

:SET<X>:LABel

Description Sets or returns the file label for the selected setup.

Syntax :SET<X>:LABel {<string> | ?}

Related commands :SET<X>:LABel:DISPlay

Parameter	<X>	Setup number 1 to 20
	<string>	The string must be no more than 8 characters and only contain alphanumeric characters in addition to period, dash and underscore characters. The string must be enclosed in double quotes, "string".
Return parameter	<string>	Returns the label for the selected setup. No return indicates that there has not been a file label assigned for the selected setup.

Example1 :SET1:LABel "SET1_lab"
 Sets the label for setup 1 as "SET1_lab".

Example2 :SET1:LABel?
 SET1_lab

DVM Commands

The DVM commands are only available when the optional DVM app is installed.

:DVM:STATE	145
:DVM:SOURce	145
:DVM:MODE.....	146
:DVM:VALue	146

:DVM:STATE



Description	Sets or queries the DVM state to on or off.	
Note	This command is only applicable when the DVM app is installed. See the DVM app user manual for details.	
Syntax	:DVM:STATE {OFF ON ? }	
Related commands	:DVM:SOURce :DVM:MODE	
Parameter/ Return parameter	OFF	Turns the DVM off.
	ON	Turns the DVM on.
Example	:DVM:STATE ON Turns the DVM state on.	

:DVM:SOURce



Description	Sets or queries the source of the DVM.	
Note	This command is only applicable when the DVM app is installed. See the DVM app user manual for details.	
Syntax	:DVM:SOURce {CH1 CH2 CH3 CH4 ?}	

Related commands	:DVM:STATE :DVM:MODE	
Parameter/ Return parameter	CH1~CH4	Channel 1 to 4.
Example	:DVM:SOURce CH1 Sets the DVM source to channel 1.	

:DVM:MODE



Description	Sets or queries the DVM mode.
Note	This command is only applicable when the DVM app is installed. See the DVM app user manual for details.

Syntax :DVM:MODE {ACRMS|DC|DCRMS|DUTY|FREQuency|?}

Related commands	:DVM:SOURce :DVM:STATE
------------------	---------------------------

Parameter/ Return parameter	ACRMS	Sets the mode to AC RMS
	DC	Sets the mode to DC
	DCRMS	Sets the mode to DC RMS
	DUTY	Sets the mode to AC Duty
	FREQuency	Sets the mode to AC frequency

Example	:DVM:MODE DUTY Sets the DVM mode to DUTY.	
---------	--	--

:DVM:VALue 

Description	Returns the measurement value of the selected mode.
Note	This command is only applicable when the DVM app is installed. See the DVM app user manual for details.

Syntax	:DVM:VALue?
Related commands	:DVM:SOURce :DVM:STATE :DVD:MODE
Return parameter	Returns the measurement value as <NR3>.
Example	:DVM:VALue? >8.410E-04 Returns the measurement.

Go_NoGo Commands

The GoNoGo APP must first be launched (or use the command, “:GONogo:SCRipt”) before any of the Go_NoGo or Template commands can be used.

:GONogo:CLear.....	148
:GONogo:EXECute	148
:GONogo:FUNCTion.....	149
:GONogo:NGCount	149
:GONogo:NGDefine.....	149
:GONogo:SOURce	150
:GONogo:VIOLation	150
:GONogo:SCRipt.....	150
:TEMPlate:MODE	151
:TEMPlate:MAXimum.....	151
:TEMPlate:MINimum.....	151
:TEMPlate:POSition:MAXimum.....	152
:TEMPlate:POSition:MINimum	152
:TEMPlate:SAVe:MAXimum	152
:TEMPlate:SAVe:MINimum	153
:TEMPlate:TOLerance.....	153
:TEMPlate:SAVe:AUTo.....	153

:GONogo:CLear

Set →

Description Clears the Go/NoGo counter.

Syntax :GONogo:CLear

:GONogo:EXECute

Set →
→ Query

Description Enables or disables the Go/NoGo function or queries its state.

Syntax :GONogo:EXECute {OFF|ON|?}

Parameter/	OFF	Disabled
Return Parameter	ON	Enabled

Example :GONogo:EXECute OFF
Turns Go/NoGo off.

:GONogo:FUNCTION (Set) →

Description Initializes the Go/NoGo APP. This must be run after the Go/NoGo APP has been started.

Syntax :GONogo:FUNCTION

:GONogo:NGCount → (Query)

Description Returns the Go/NoGo counter.

Syntax :GONogo:NGCount{?}

Return parameter Returns a string in the following format “number of violations,total tests”

Example :GONogo:NGCount?
> 3,25
Indicates that 3 violations occurred over 25 tests.

:GONogo:NGDefine (Set) →
→ (Query)

Description Sets the Go/NoGo “When” conditions.

Syntax :GONogo:NGDefine {EXITs|ENTers}?

Parameter/	EXITs	Sets the NoGo condition to when the input signal exceeds the limit boundary.
Return Parameter	ENTers	Sets the NoGo condition to when the input signal stays within the limit boundary.

Example :GONogo:NGDefine EXITs
Sets the Go/NoGo condition to EXITs.



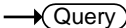

:GONogo:SOURce

Description	Sets the source for the Go/NoGo signal.	
Syntax	:GONogo:SOURce {CH1 CH2 CH3 CH4 ?}	
Parameter/ Return Parameter	CH1~CH4	
Example	:GONogo:SOURce CH1 Sets the source to CH1.	



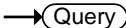

:GONogo:VIOLation

Description	Sets or returns actions for the Go/NoGo violations.	
Syntax	:GONogo:VIOLation {STOP CONTInue ?}	
Parameter/ Return Parameter	STOP	The waveform will be frozen.
	CONTInue	Ignore the violation.
Example	:GONogo:VIOLation STOP Sets violation action to STOP.	



:GONogo:SCRipt

Description	Activates/Deactivates the Go/NoGo APP or queries its state.	
Syntax	:GONogo:SCRipt {OFF ON ?}	
Parameter/ Return Parameter	ON	Turns Go/NoGo APP on.
	OFF	Turns the Go/NoGo APP off.
Example	:GONogo:SCRipt? >ON The Go/NoGo script is on.	

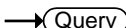
	 						
:TEMPlate:MODE							
Description	Sets or returns the Go/NoGo template mode.						
Syntax	:TEMPlate:MODE {MAXimum MINimum AUTO ?}						
Parameter/ Return Parameter	<table style="width: 100%; border-collapse: collapse;"> <tr> <td style="width: 20%; background-color: #e0e0e0;">MAXimum</td> <td>Maximum template</td> </tr> <tr> <td style="background-color: #e0e0e0;">MINimum</td> <td>Minimum template</td> </tr> <tr> <td style="background-color: #e0e0e0;">AUTO</td> <td>Auto template</td> </tr> </table>	MAXimum	Maximum template	MINimum	Minimum template	AUTO	Auto template
MAXimum	Maximum template						
MINimum	Minimum template						
AUTO	Auto template						
Example	<p>:TEMPlate:MODE AUTO</p> <p>Sets the template mode to AUTO.</p>						

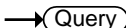
	 				
:TEMPlate:MAXimum					
Description	Defines or queries which waveform memory (REF1 or W1~W20) is set to the maximum template.				
Syntax	:TEMPlate:MAXimum {REF1 W1~W20 ?}				
Parameter/ Return Parameter	<table style="width: 100%; border-collapse: collapse;"> <tr> <td style="width: 20%; background-color: #e0e0e0;">REF1</td> <td>Reference one</td> </tr> <tr> <td style="background-color: #e0e0e0;">W1~W20</td> <td>Waveform memory 1 to 20</td> </tr> </table>	REF1	Reference one	W1~W20	Waveform memory 1 to 20
REF1	Reference one				
W1~W20	Waveform memory 1 to 20				
Example	<p>:TEMPlate:MAXimum REF1</p> <p>Saves the maximum template to REF1.</p>				

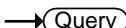
	 				
:TEMPlate:MINimum					
Description	Defines or queries which waveform memory (REF2 or W1~W20) is set to the minimum template.				
Syntax	:TEMPlate:MINimum {REF2 W1~W20 ?}				
Parameter/ Return Parameter	<table style="width: 100%; border-collapse: collapse;"> <tr> <td style="width: 20%; background-color: #e0e0e0;">REF2</td> <td>Reference two</td> </tr> <tr> <td style="background-color: #e0e0e0;">W1~W20</td> <td>Waveform memory 1 to 20</td> </tr> </table>	REF2	Reference two	W1~W20	Waveform memory 1 to 20
REF2	Reference two				
W1~W20	Waveform memory 1 to 20				
Example	<p>:TEMPlate:MINimum REF2</p> <p>Saves the minimum template to REF2.</p>				

Set →
 → Query

:TEMPlate:POSition:MAXimum

Description	Sets or queries the position of the maximum template.	
Syntax	:TEMPlate:POSition:MAXimum {<NR2> ?}	
Parameter	<NR2>	Desired template position (-12.0 ~ +12.0 divisions)
Return parameter	Returns the position in the following format: “<NR2>Div”	
Example	:TEMPlate:POSition:MAXimum 3.00 Sets the maximum template position to 3.00 divisions.	

Set →
 → Query

:TEMPlate:POSition:MINimum

Description	Sets or queries the position of the minimum template.	
Syntax	:TEMPlate:POSition:MINimum {<NR2> ?}	
Parameter	<NR2>	Desired template position (-12.0 ~ +12.0 divisions)
Return parameter	Returns the position in the following format: “<NR2>Div”	
Example	:TEMPlate:POSition:MINimum 3.00 Sets the minimum template position to 3.00 divisions.	

Set →

:TEMPlate:SAVe:MAXimum

Description	Saves the maximum template.	
Syntax	:TEMPlate:SAVe:MAXimum	

:TEMPlate:SAVe:MINimum (Set) →

Description Saves the maximum template.

Syntax :TEMPlate:SAVe:MINimum

:TEMPlate:TOLerance (Set) →
→ (Query)

Description Sets or queries the tolerance as a percentage.

Syntax :TEMPlate:TOLerance {<NR2>|?}

Parameter/ Return Parameter	<NR2>	The auto tolerance range (0.4% ~ 40%)
--------------------------------	-------	---------------------------------------

Example :TEMPlate:TOLerance 10
 Sets the tolerance to 10%.

:TEMPlate:SAVe:AUTO (Set) →

Description Saves the AUTO template (maximum and minimum templates).

Syntax :TEMPlate:SAVe:AUTO

Data Logging Commands

The data logging commands are only applicable after the optional Data Log app has been installed.

:DATALOG:STATE	154
:DATALOG:SOURce	155
:DATALOG:SAVe	155
:DATALOG:INTerval	156
:DATALOG:DURation	157

:DATALOG:STATE





Description	Sets or queries the state of the data logging app.	
Note	This command is only applicable when the Datalog app is installed. See the Datalog user manual for details.	
Syntax	:DATALOG:STATE {OFF ON ?}	
Related commands	:DATALOG:SOURce :DATALOG:SAVe :DATALOG:INTerval :DATALOG:DURation	
Parameter/ Return parameter	OFF	Turns the data logging off.
	ON	Turns the data logging on.
Example	:DATALOG:STATE ON Turns the data logging app on.	

		Set →
		→ Query
:DATALOG:SOURce		
Description	Sets or queries the data logging source channel.	
Note	This command is only applicable when the Datalog app is installed. See the Datalog user manual for details.	
Syntax	:DATALOG:SOURce {CH1~CH4 all ?}	
Related commands	:DATALOG:STATE :DATALOG:SAVE :DATALOG:INTERval :DATALOG:DURation	
Parameter/Return parameter	CH1 ~CH4 all	Channel 1, 2, 3 or 4 All displayed channels.
Example	:DATALOG:SOURce CH1 Sets the source to CH1.	

		Set →
		→ Query
:DATALOG:SAVE		
Description	Sets or queries the save format as image or waveform.	
Note	This command is only applicable when the Datalog app is installed. See the Datalog user manual for details.	
Syntax	:DATALOG:SAVE {IMAGE WAVEform ?}	
Related commands	:DATALOG:STATE :DATALOG:SOURce :DATALOG:INTERval :DATALOG:DURation	
Parameter/Return parameter	IMAGE WAVEform	Save as images. Save as waveforms.

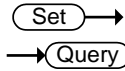
Example :DATALOG:SAVe WAVEform
 Sets the save format to waveform.



:DATALOG:INTerval

Description Sets or queries the recording interval time in seconds. The interval times that can be set are dependent on the settings of the DATALOG:SOURce and DATALOG:SAVe commands.

Note This command is only applicable when the Datalog app is installed. See the Datalog user manual for details.

Syntax :DATALOG:INTerval {<NR1>|?}

Related commands :DATALOG:STATE
 :DATALOG:SOURce
 :DATALOG:SAVe
 :DATALOG:DURation

Parameter/Return parameter	<NR1>	Sets or returns the interval time in discrete seconds: Interval time for DATALOG:SOURce = All or DATALOG:SAVe=IMAGE: 5, 10, 15, 20, 25, 30, 35, 60, 120 Interval time for DATALOG:SOURce = CH1~CH4: 2, 3, 4, 5, 10, 20, 30, 60, 120
----------------------------	-------	--

Example :DATALOG:INTerval 5
 Sets the recording interval to 5 seconds.

Set →

→ Query

:DATALOG:DURation

Description	Sets or queries the recording duration time in minutes.	
Note	This command is only applicable when the Datalog app is installed. See the Datalog user manual for details.	
Syntax	:DATALOG:DURation {<NR1> ?}	
Related commands	:DATALOG:STATE :DATALOG:SOURce :DATALOG:SAVe :DATALOG:INTerval	
Parameter/Return parameter	<NR1>	Sets returns the duration time in discrete minutes: 5, 10, 15, 20, 25, 30, 60, 90, 120, 150, 180, 210, 240, 270, 300, 330, 360, 390, 420, 450, 480, 510, 540, 570, 600, 1200, 1800, 2400, 3000, 3600, 4200, 4800, 5400, 6000
Example	:DATALOG:DURation 10 Sets the recording duration to 10 minutes.	

Remote Disk Commands

The remote disk commands are only available on 4 channel models.

:REMOTEDisk:IPADDRESS.....	158
:REMOTEDisk:PATHName.....	158
:REMOTEDisk:USERName.....	159
:REMOTEDisk:PASSWord.....	159
:REMOTEDisk:MOUNT.....	159
:REMOTEDisk:AUTOMount.....	160

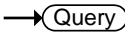
	
:REMOTEDisk:IPADDRESS	

Description	Sets or returns the IP address of remote disk.
Note	This command is only available on 4 channel models.
Syntax	:REMOTEDisk:IPADDRESS {<string> ?}
Parameter/ Return parameter	<string> IP address enclosed in double quotes. Eg., 172.16.20.255
Example	:REMOTEDisk:IPADDRESS "172.16.20.255" Sets the remote disk IP address as 172.16.20.255.

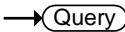
	
:REMOTEDisk:PATHName	

Description	Sets or returns the file path of the remote disk.
Note	This command is only available on 4 channel models.
Syntax	:REMOTEDisk:PATHName {<string> ?}
Parameter/ Return parameter	<string> File path is enclosed in double quotes eg., "remote_disk"
Example	:REMOTEDisk:PATHName "remote_disk" Sets the file path to c:/remote_disk.

		Set →
		→ Query
:REMOTEDisk:USERName		
Description	Sets or queries the account username for the remote disk.	
Note	This command is only available on 4 channel models.	
Syntax	:REMOTEDisk:USERName {<string> ? }	
Parameter/Return parameter	<string>	User name enclosed in double quotes eg., "User_Name".
Example	:REMOTEDisk:USERName "User_Name" Sets the account name as User_Name.	

		Set →
		→ Query
:REMOTEDisk:PASSWord		
Description	Sets or queries the account password for the remote disk.	
Note	This command is only available on 4 channel models.	
Syntax	:REMOTEDisk:PASSWord {<string> ? }	
Parameter/Return parameter	<string>	Username password enclosed in double quotes eg., "Password".
Example	:REMOTEDisk:PASSWord "Password" Sets the account password as Password.	

		Set →
		→ Query
:REMOTEDisk:MOUNT		
Description	Mounts/Unmounts the remote disk or queries its state.	
Note	This command is only available on 4 channel models.	
Syntax	:REMOTEDisk:MOUNT { OFF ON ? }	

Parameter/Return parameter	OFF	Unmount remote disk
	ON	Mount remote disk
Example	<pre>:REMOTEDisk:IPADdress "172.16.5.154" :REMOTEDisk:PATHName "remote_disk" :REMOTEDisk:USERName "guest" :REMOTEDisk:PASSWord "password" :REMOTEDisk:MOUNT ON</pre> <p>Sets the remote disk parameters and mounts the remote disk.</p>	

:REMOTEDisk:AUTOMount
 →
 ←

Description	Turns automount on/off or queries its state. The remote disk must be configured beforehand.	
Note	This command is only available on 4 channel models.	
Syntax	:REMOTEDisk:AUTOMount { OFF ON ? }	
Parameter/Return parameter	OFF	Don't mount the remote disk at start up.
	ON	Automatically mount the remote disk on start up.
Example	<pre>:REMOTEDisk:AUTOMount ON</pre> <p>Turns the automount function on.</p>	

APPENDX

Error messages

Description The following error messages may be returned from the :SYSTem:ERRor? query. For details see page 134.

List of error messages	Error number, "Error Description"
	+0, "No error."
	-100, "Command error"
	-101, "Invalid character"
	-102, "Syntax error"
	-103, "Invalid separator"
	-104, "Data type error"
	-105, "GET not allowed"
	-108, "Parameter not allowed"
	-109, "Missing parameter"
	-110, "Command header error"
	-111, "Header separator error"
	-112, "Program mnemonic too long"
	-113, "Undefined header"
	-114, "Header suffix out of range"
	-115, "Unexpected number of parameters"
	-120, "Numeric data error"
	-121, "Invalid character in number"
	-123, "Exponent too large"
	-124, "Too many digits"
	-128, "Numeric data not allowed"
	-130, "Suffix error"
	-131, "Invalid suffix"
	-134, "Suffix too long"
	-138, "Suffix not allowed"

- 140, "Character data error"
- 141, "Invalid character data"
- 144, "Character data too long"
- 148, "Character data not allowed"
- 150, "String data error"
- 151, "Invalid string data"
- 158, "String data not allowed"
- 160, "Block data error"
- 161, "Invalid block data"
- 168, "Block data not allowed"
- 170, "Expression error"
- 171, "Invalid expression"
- 178, "Expression data not allowed"
- 180, "Macro error"
- 181, "Invalid outside macro definition"
- 183, "Invalid inside macro definition"
- 184, "Macro parameter error"

- 200, "Execution error"
- 201, "Invalid while in local"
- 202, "Settings lost due to rtl"
- 203, "Command protected"
- 210, "Trigger error"
- 211, "Trigger ignored"
- 212, "Arm ignored"
- 213, "Init ignored"
- 214, "Trigger deadlock"
- 215, "Arm deadlock"
- 220, "Parameter error"
- 221, "Settings conflict"
- 222, "Data out of range"
- 223, "Too much data"
- 224, "Illegal parameter value"
- 225, "Out of memory"
- 226, "Lists not same length"
- 230, "Data corrupt or stale"
- 231, "Data questionable"
- 232, "Invalid format"
- 233, "Invalid version"
- 240, "Hardware error"

- 241, "Hardware missing"
- 250, "Mass storage error"
- 251, "Missing mass storage"
- 252, "Missing media"
- 253, "Corrupt media"
- 254, "Media full"
- 255, "Directory full"
- 256, "File name not found"
- 257, "File name error"
- 258, "Media protected"
- 260, "Expression error"
- 261, "Math error in expression"
- 270, "Macro error"
- 271, "Macro syntax error"
- 272, "Macro execution error"
- 273, "Illegal macro label"
- 274, "Macro parameter error"
- 275, "Macro definition too long"
- 276, "Macro recursion error"
- 277, "Macro redefinition not allowed"
- 278, "Macro header not found"
- 280, "Program error"
- 281, "Cannot create program"
- 282, "Illegal program name"
- 283, "Illegal variable name"
- 284, "Program currently running"
- 285, "Program syntax error"
- 286, "Program runtime error"
- 290, "Memory use error"
- 291, "Out of memory"
- 292, "Referenced name does not exist"
- 293, "Referenced name already exists"
- 294, "Incompatible type"

- 300, "Device-specific error"
- 310, "System error"
- 311, "Memory error"
- 312, "PUD memory lost"
- 313, "Calibration memory lost"
- 314, "Save/recall memory lost"

- 315, "Configuration memory lost"
- 320, "Storage fault"
- 321, "Out of memory"
- 330, "Self-test failed"
- 340, "Calibration failed"
- 350, "Queue overflow"
- 360, "Communication error"
- 361, "Parity error in program message"
- 362, "Framing error in program message"
- 363, "Input buffer overrun"
- 365, "Time out error"

- 400, "Query error"
- 410, "Query INTERRUPTED"
- 420, "Query UNTERMINATED"
- 430, "Query DEADLOCKED"
- 440, "Query UNTERMINATED after indefinite response"

INDEX

ACQuire		VDELta	63
AVERAge	35	VUNI	60
HEADer	41	VUSE	61
MEMory	36	XY	
MODE	36	POLar	
RECOrdlength	40	RADIUS	
STATe	38, 39, 40	DELta	65
AUTORSET		POSition	65
MODE	42	THETA	
AUTOSet	42	DELta	66
CHANnel		POSition	66
BWLimit	43	PRODUct	
COUPling	44	DELta	67
DESKew	44	POSition	66
DISPlay	44	RATio	
EXPand	45	DELta	67
IMPedance	45, 55	RATio	
INVert	46	POSition	67
LABel	141	RECTangular	
DISPlay	142	X	
POSition	46	DELta	64
PROBE		POSition	63
TYPE	47	Y	
PROBE		DELta	65
RATio	47	POSition	64
SCALe	47	DATALOG	
CLS	31	DURation	157
CURSor		INTERval	156
DDT	61	SAVE	155, 159, 160
H1Position	61	SOURce	155, 159
H2Position	62	STATE	154, 158
HDELta	62	DISPlay	
HUNI	59	GRATicule	71
HUSE	60	INTensity	
MODE	58	GRATicule	69, 70
SOURce	59	WAVEform	69
V1Position	62, 63	OUTPut	72
		PERSistence	71
		WAVEform	72
		DVM	
		MODE	146

SOURce 145
 STATE 145
 Error list 161
 Ethernet
 interface 8
 ETHERnet
 DHCP 140
 FORCE 113
 GONogo
 CLEar 148
 EXECute 148
 FUNctIon 149
 NGCount 149
 NGDefine 149
 SCRipt 150
 SOURce 150
 VIOLation 150
 HARDcopy
 ASSIGN 75
 MODE 73
 PRINTINKSaver 74
 SAVEFORMat 74
 SAVEINKSaver 74
 START 73
 HEADER 41
 IDN? 29
 Interface 5
 LRN? 29
 MATH
 ADVanced
 OPERator 54
 POSition 56
 SCALE 56
 DISP 49
 DUAL
 OPERator 50
 POSition 51
 SCALE 51
 SOURce 50
 FFT
 HORizontal
 SCALE 54
 MAG 52
 POSition 53, 54

SCALE 53
 SOURce 52
 WINDow 52
 TYPE 50

MEASURE

AMPLitude 88
 AREa 94
 CAREa 94
 CMEan 89
 FALL 80
 FFFDelay 97
 FFRDelay 96
 FOVShoot 80
 FPReshoot 81
 FREQuency 81
 FRFDelay 95
 FRRDelay 95
 GATing 77
 HIGH 90
 LFFDelay 99
 LFRDelay 98
 LOW 90
 LRFDelay 98
 LRRDelay 97
 MAX 91
 MEAN 88
 METHod 78, 79
 MIN 91
 NEDGE 87
 NPULSE 86
 NWIDTH 82
 PDUTy 82
 PEDGE 87
 PERiod 83
 PHase 100
 PK2PK 92
 PPULSE 86
 PWIDth 83
 RISE 84
 RMS 92, 93
 ROVShoot 84
 RPReshoot 85
 SOURce 77

MEASUREMENT

MEAS
 MAXimum 104
 MEAN 105
 MINimum 105
 SOURCE 101

STATE	102	LOCK.....	134
STDdev.....	106	TEMPlate	
TYPe	102	MAXimum.....	151
VALue.....	103	MINimum.....	151
STATISTICS.....	108	MODE.....	151
MODE.....	107	POSition	
WEIghting	107	MAXimum.....	152
RCL.....	31	MINimum.....	152
RECALL		SAVe	
SETUp	135	AUTo.....	153
WAVEform.....	135	MAXimum.....	152
REF		MINimum.....	153
DISPlay.....	109	TOLerance	153
LABel.....	142	TIMEbase	
DISPlay.....	143	EXPand.....	114
OFFSet	110	MODE.....	115
SCALe.....	111	POSition	114
TIMEbase		SCALe.....	114
POSition	109	WINDow	
SCALe	110	POSition.....	115
Remote control		SCALe.....	116
interface configuration	5	TRIGger	
RST.....	31	ALternate.....	131
RUN.....	112	COUPle	119
SAV.....	30	DELAy	
SAVE		EVENT.....	123
IMAGe.....	136	LEVel	124
FILEFormat.....	136	SLOP.....	122
INKSaver	137	TIME.....	123
SETUp	137	TYPe.....	123
WAVEform.....	138	EDGE	
FILEFormat.....	139	SLOP	122
SET		EXTERnal	
LABel.....	144	PROBe	
SINGLE.....	112	RATio.....	133
Socket server		TYPe.....	132
function check.....	11	FREQuency	118
Socket server		HLEVel.....	120, 121
interface.....	10	HOLDoff	120
STOP.....	112	LLEVel.....	121
SYSTem		MODE.....	120
ERRor	134	NREJ	119
		PULSe	
		TIME.....	130
		WHEn.....	129
		PULSEWidth	
		POLarity.....	124
		RISEFall	
		SLOP.....	126
		Time	127

WHEn	126	TYPE	118
RUNT		VIDeo	
POLarity	125	FIEld	128
TIMe	126	LINE	129
WHEn	125	POLarity	129
SOURce	119	TYPe	127
STATe	131	USB	
TIMEOut		function check	7
TIMER	131	remote control interface	5
WHEn	130		